

B09 Cover

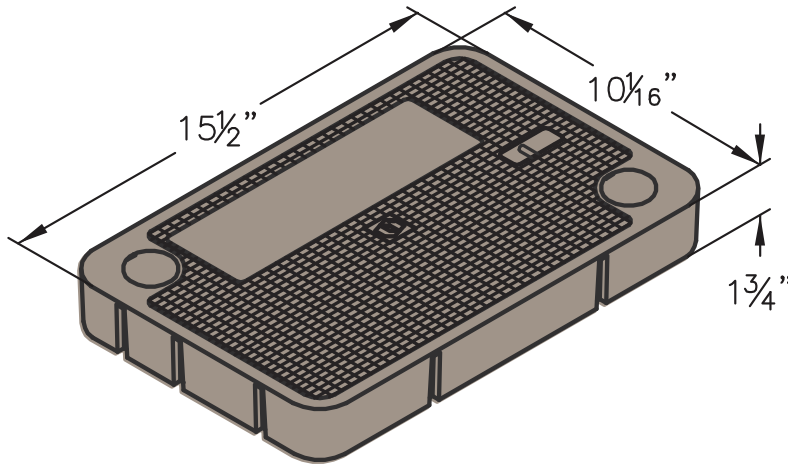

Material & Style

Composite with UV Inhibitor
Flush
Skid Resistant & Marked*
10" x 15"
20 lbs
Cover comes standard with permanent markings for manufacturer, load rating, model size and manufacturing location.

Performance & Weight

>0.6 ASTM 1028
ASTM C 857

Options

Bolt Down Kit
Special Markings



Light Duty
PEDESTRIAN /
GREENBELT

For use in non-vehicular traffic situations only. Weights and dimensions may vary slightly. Actual load rating is determined by the box and cover combination.

Cover Options

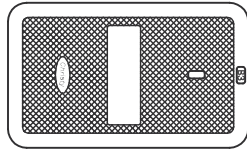

Concrete Flush

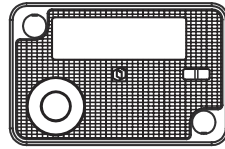

R-Series with AMR Opening

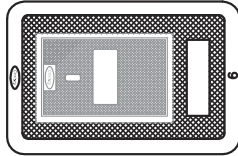

Concrete with
Cast Iron Reader Door

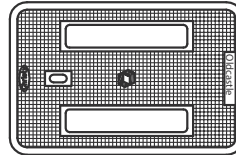

Cast Iron
Flush

- R-Series, Flush Solid
- R-Series, Flush with AMR Opening
- Concrete, Flush with Cast Iron Reader Door
- Concrete, Slab
- Cast Iron, Flush Solid
- Steel Checker Plate, Solid
- Steel Checker Plate, with Reader Door

Cover Options

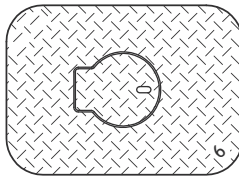

Steel with 6" Round
Reader Door

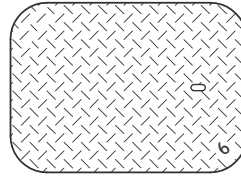

Steel Checker Plate

- Bolt Down Locking (R-Series Covers)
- Universal TL Key Locking (Cast Iron Covers)
- Galvanizing (Steel Covers)

All information contained on this sheet is current at the time of publication.
Oldcastle Infrastructure reserves the right to discontinue or update product information without notice.

Revision 02/2025

© 2025 Oldcastle Infrastructure, Inc.