

SITE SPECIFIC DATA				
Structure ID	ID			
Treatment Flow Rate (cfs)	-			
Peak Flow Rate (cfs)	-			
Rim Elevation	-			
Pipe Data	Pipe Location	Pipe Size	Pipe Type	Invert Elevation
Outlet	-	-	-	-
Notes:				
PERFORMANCE SPECIFICATIONS				
Treatment Flow Capacities:				
NJDEP 80% Removal, 75 micron	0.115 cfs			
WA Ecology GULD - Basic, Enhanced & Phosphorus	0.103 cfs			
Bypass Capacity	2.0 cfs			
*Contact Oldcastle for alternative treatment flow capacities.				

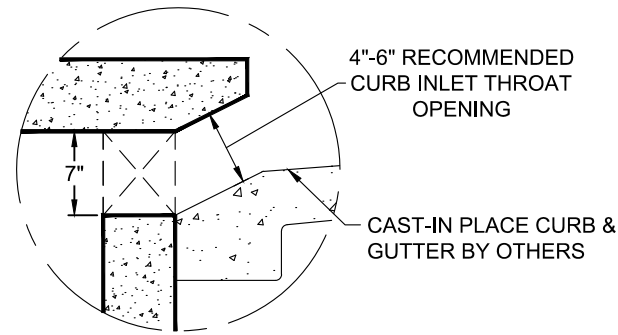

CURB INLET DETAIL

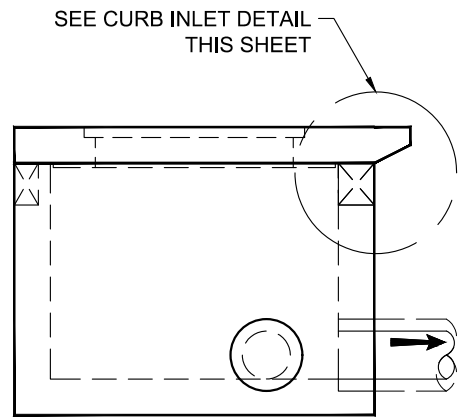

LEFT END VIEW

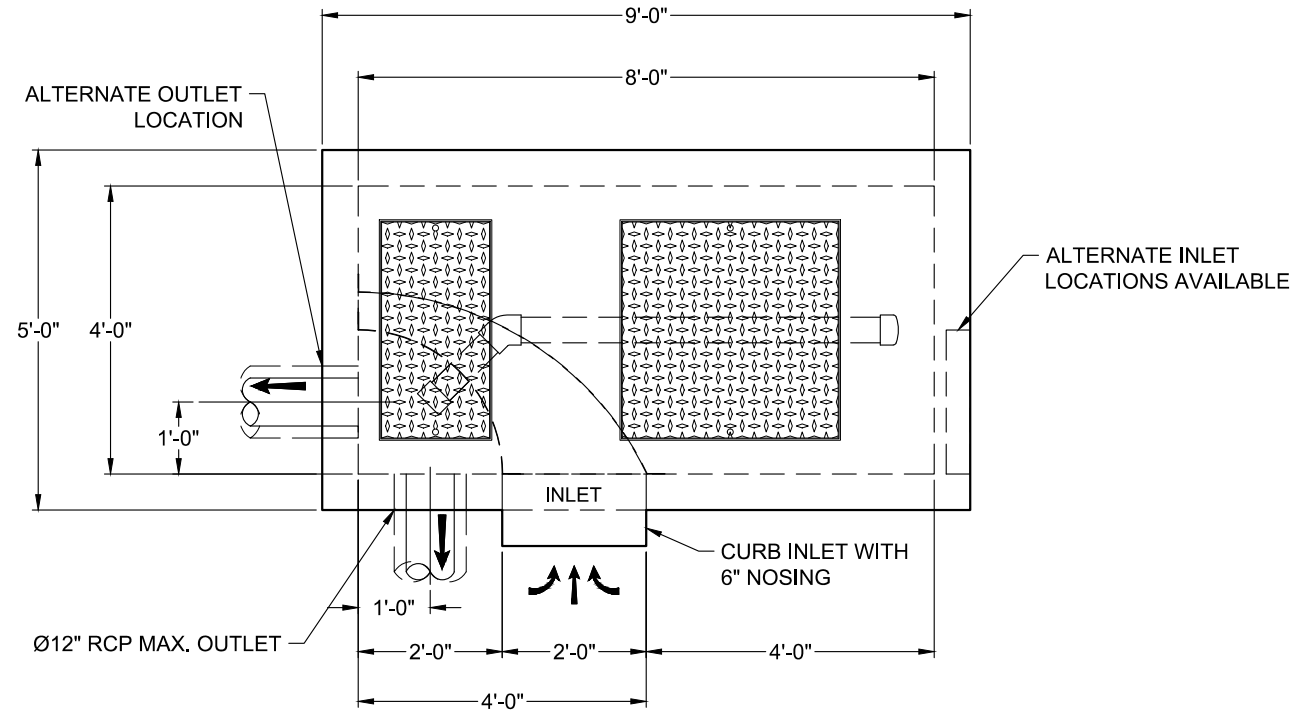

PLAN VIEW

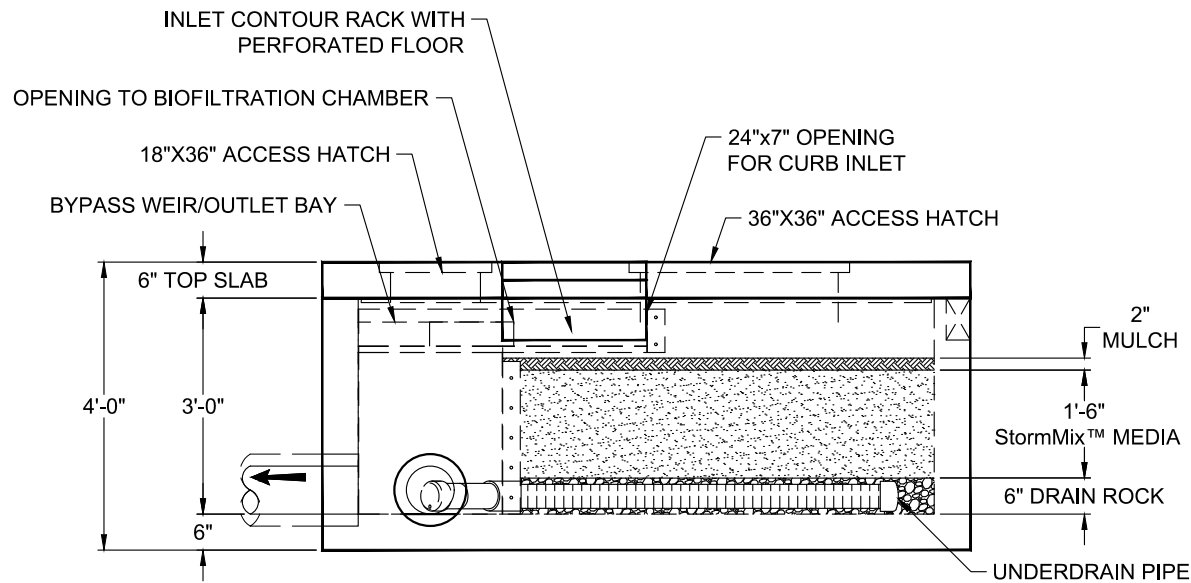

ELEVATION VIEW

- NOTES:**
- DESIGN LOADINGS:
 - 300 PSF PEDESTRIAN LOADING
 - DESIGN SOIL COVER: 0' MAXIMUM
 - ASSUMED WATER TABLE: BELOW BASE OF PRECAST (ENGINEER-OF-RECORD TO CONFIRM SITE WATER TABLE ELEVATION)
 - LATERAL EARTH PRESSURE: 45 PCF (DRAINED)
 - LATERAL LIVE LOAD SURCHARGE: 80 PSF (APPLIED TO 8'-0" BELOW GRADE)
 - NO LATERAL SURCHARGE FROM ADJACENT BUILDINGS, WALLS, PIERS, OR FOUNDATIONS.
 - CONCRETE 28-DAY MINIMUM COMPRESSIVE STRENGTH: 5,000 PSI MINIMUM.
 - REINFORCING: REBAR, ASTM A615/A706, GRADE 60
 - CEMENT: ASTM C150
 - REQUIRED ALLOWABLE SOIL BEARING CAPACITY: 2,500 PSF
 - REFERENCE STANDARD:
 - ASTM C890
 - ASTM C913
 - ACI 318-14
 - THIS STRUCTURE IS DESIGNED TO THE PARAMETERS NOTED HEREIN. ENGINEER-OF-RECORD SHALL VERIFY THAT NOTED PARAMETERS MEET OR EXCEED PROJECT REQUIREMENTS. IF DESIGN PARAMETERS ARE INCORRECT, REVIEWING ENGINEER/AUTHORITY SHALL NOTIFY OLDCASTLE INFRASTRUCTURE UPON REVIEW.
 - INLET AND OUTLET HOLES WILL BE FACTORY CORED/CAST PER PLANS AND CUSTOMER REQUIREMENTS. INLET AND OUTLET LOCATIONS CAN BE MIRRORED.
 - CONTRACTOR RESPONSIBLE TO VERIFY ALL SIZES, LOCATIONS, AND ELEVATIONS OF OPENINGS.
 - CONTRACTOR RESPONSIBLE TO ENSURE ADEQUATE BEARING SURFACE IS PROVIDED (I.E. COMPACTED AND LEVEL PER PROJECT SPECIFICATIONS).
 - SECTION HEIGHTS, SLAB/WALL THICKNESSES, AND KEYWAYS ARE SUBJECT TO CHANGE AS REQUIRED FOR SITE REQUIREMENTS AND/OR DUE TO PRODUCT AVAILABILITY AND PRODUCTION FACILITY CONSTRAINTS.
 - MAXIMUM PICK WEIGHTS*:
 - TOP: XX,XXX LBS
 - BASE: XX,XXX LBS* (* COMBINED WEIGHT OF BASE INCLUDES BYPASS WEIR, DIVIDER WALL, ROCK & MEDIA)
 - INTERNALS SHALL CONSIST OF UNDERDRAIN PIPE, ROCK, STORMMIX™ MEDIA, MULCH, AND INLET CONTOUR RACK.



Ph: 800.579.8819 | www.oldcastleinfrastructure.com/stormwater
 THIS DOCUMENT IS THE PROPERTY OF OLDCASTLE INFRASTRUCTURE, INC. IT IS CONFIDENTIAL, SUBMITTED FOR REFERENCE PURPOSES ONLY AND SHALL NOT BE USED IN ANY WAY INJURIOUS TO THE INTERESTS OF, OR WITHOUT THE WRITTEN PERMISSION OF OLDCASTLE INFRASTRUCTURE, INC. COPYRIGHT © 2021 OLDCASTLE INFRASTRUCTURE, INC. ALL RIGHTS RESERVED.

BioPod™ Biofilter System (STANDARD)		
Surface Vault with Internal Bypass		
CUSTOMER		
PROJECT NAME		
SHEET NAME	REVISION	SHEET
Specifier Drawing BPS-481B	REV DATE	1 OF 1

