

SITE SPECIFIC DATA				
Structure ID				
Water Quality Flow Rate (cfs)				
Peak Flow Rate (cfs)				
Rim Elevation				
Pipe Data	Pipe Angle*	Pipe Size	Pipe Type	Invert Elevation
Inlet				
Inlet				
Outlet at 0°				
* Angle is Clockwise from Outlet at 0°.				
Notes:				

- DESIGN NOTES:
- DESIGN LOADINGS:
 - AASHTO HS-20-44 W/ IMPACT.
 - DESIGN FILL: 5' MAXIMUM.
 - ASSUMED WATER TABLE = BELOW BOTTOM OF PRECAST.
 - DRY LATERAL EARTH PRESSURE (EFP) = 45 PCF.
 - LATERAL LIVE LOAD SURCHARGE = 80 PSF (APPLIED TO 8' BELOW GRADE).
 - NO LATERAL SURCHARGE FROM ADJACENT BUILDINGS, WALLS, PIERS, OR FOUNDATIONS.
 - CONCRETE 28 DAY COMPRESSIVE STRENGTH SHALL BE 5,000 PSI MINIMUM.
 - STEEL REINFORCEMENT: REBAR, ASTM A-615 OR A-706, GRADE 60.
 - CEMENT: ASTM C-150 SPECIFICATION.
 - REQUIRED NATIVE ALLOWABLE SOIL BEARING PRESSURE = 2,500 PSF.
 - REFERENCE STANDARD:
 - ASTM C 478
 - ASTM C 497
 - THIS STRUCTURE IS DESIGNED TO THE PARAMETERS NOTED HEREIN. PLEASE VERIFY THAT THESE PARAMETERS MEET PROJECT REQUIREMENTS (I.E. LIVE LOAD, FILL RANGE, WATER TABLE). IF DESIGN PARAMETERS ARE INCORRECT, REVIEWING ENGINEER/AUTHORITY SHALL NOTIFY OLDCASTLE PRECAST® STORMWATER UPON REVIEW OF THIS SUBMITTAL.
- GENERAL NOTES:
- TREATMENT CAPACITY IS DEPENDENT ON LOCAL REGULATORY REQUIREMENTS. BYPASS CAPACITY IS DEPENDENT ON OUTLET PIPE DIAMETER. CONTACT OLDCASTLE PRECAST® STORMWATER FOR PROJECT-SPECIFIC TREATMENT AND BYPASS SIZING RECOMMENDATIONS.
 - STANDARD INLET/OUTLET PIPE CONFIGURATION TO ENTER AND EXIT STRUCTURE AT 180°. SPECIAL ANGLED CONFIGURATIONS AVAILABLE.
 - OVERSIZED HOLES TO ACCOMMODATE SPECIFIC PIPE TYPE MUST BE CONCENTRIC TO PIPE ID. ALL ANNULAR SPACES SHALL BE FILLED WITH A MINIMUM OF 3000 PSI CONCRETE FOR FULL THICKNESS OF PRECAST WALLS.
 - CONTRACTOR RESPONSIBLE TO ENSURE ADEQUATE BEARING SURFACE IS PROVIDED (I.E. COMPACTED & LEVEL PER PROJECT SPECIFICATIONS)
 - FOR SITE SPECIFIC DRAWINGS WITH DETAILED STRUCTURE DIMENSIONS AND WEIGHTS, PLEASE CONTACT OLDCASTLE PRECAST® STORMWATER.

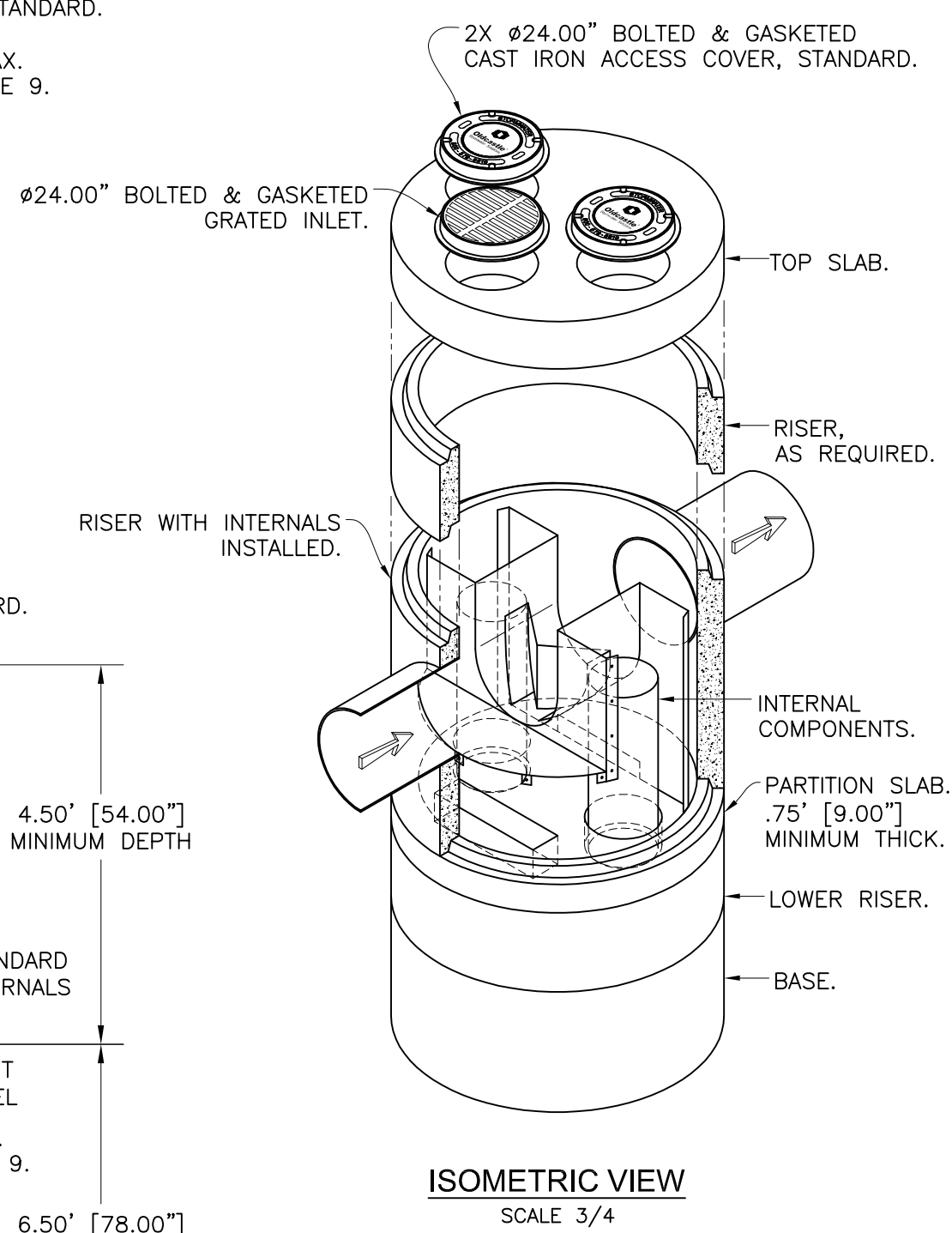

THIS PRODUCT IS PROTECTED BY THE FOLLOWING US PATENT: 7,182,874; RELATED FOREIGN PATENTS, OR OTHER PATENTS PENDING.

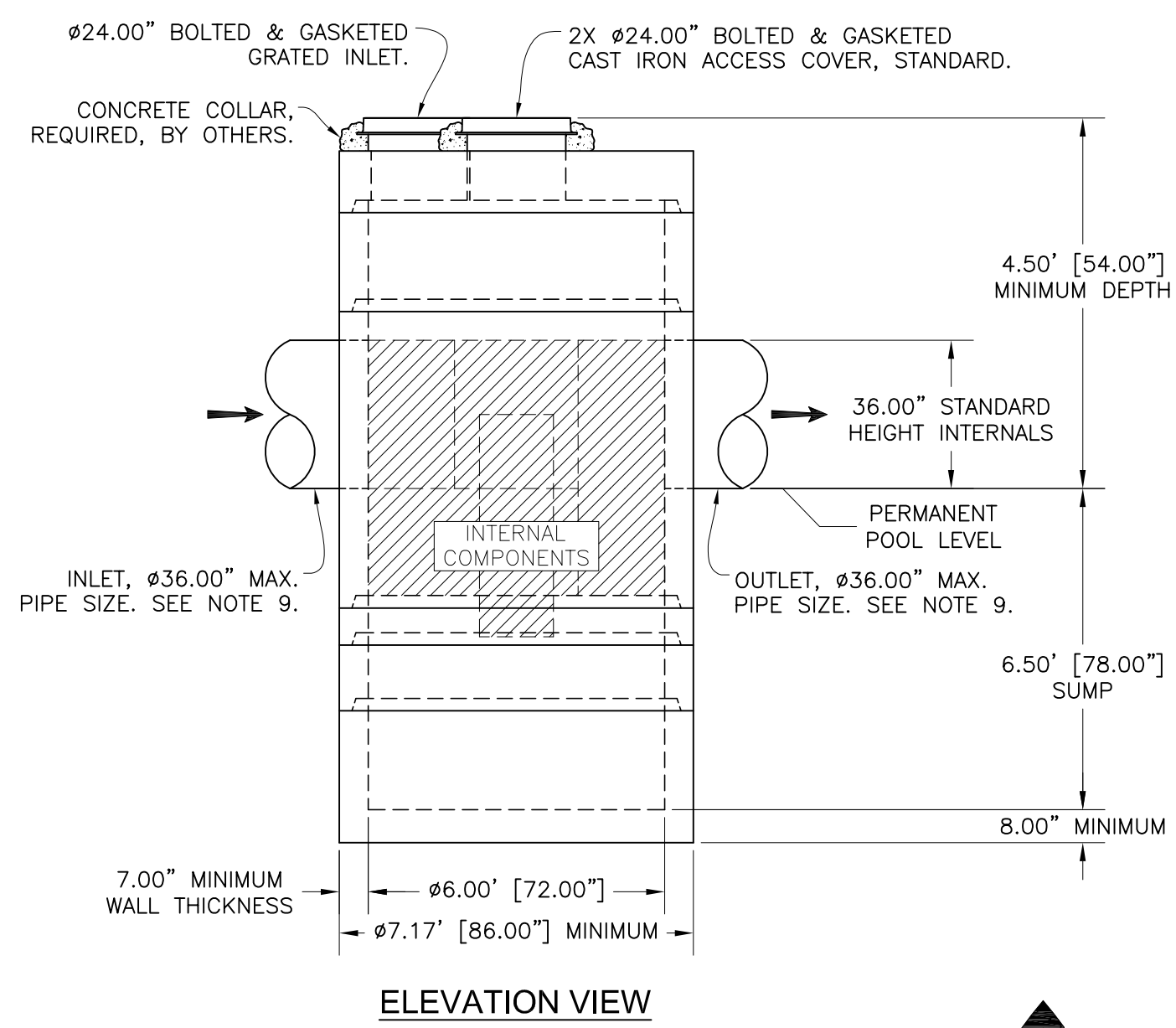
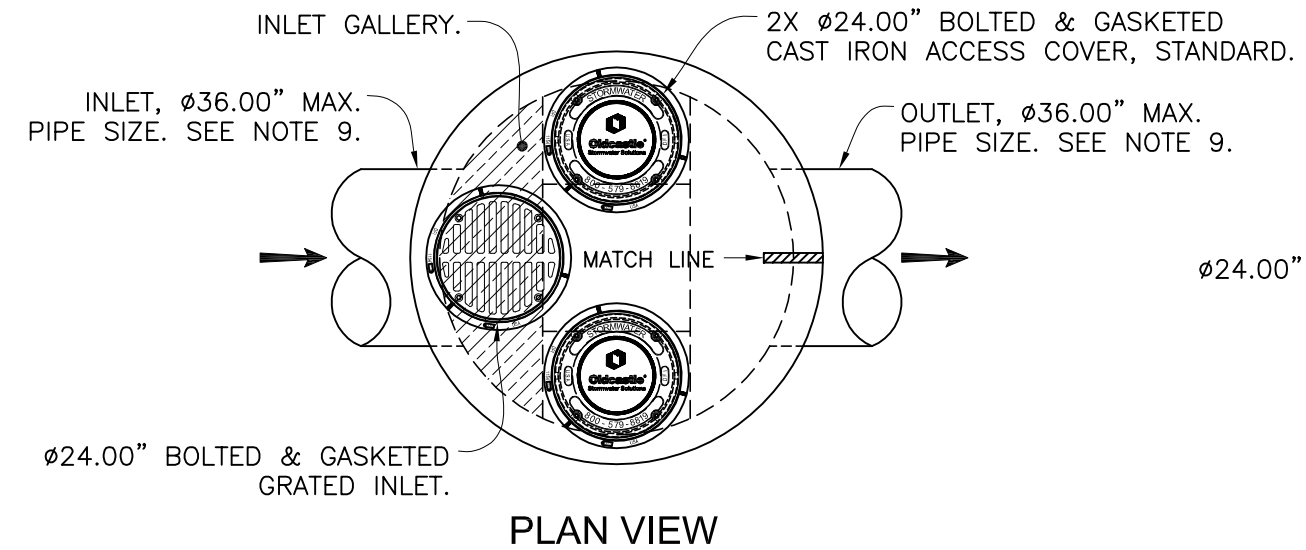
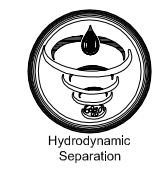



7921 Southpark Plaza, Suite 200 | Littleton, CO | 80120
Ph: 800.579.8819 | oldcas@stormwater.com

THIS DOCUMENT IS THE PROPERTY OF OLDCASTLE PRECAST, INC. IT IS SUBMITTED FOR REFERENCE PURPOSES ONLY AND SHALL NOT BE USED IN ANY WAY INJURIOUS TO THE INTERESTS OF SAID COMPANY.

COPYRIGHT © 2017 OLDCASTLE PRECAST, INC. ALL RIGHTS RESERVED.

DVS-72C-GI

Customer: _____

Job Name: _____

DRAWING NUMBER	REVISION	SHEET
DVS-72C-GI-SC	0	1 OF 1
	REV DATE	
	N/A	