

108" MANHOLE

FRAME AND COVER

3" = 275 lbs.
7" = 350 lbs.

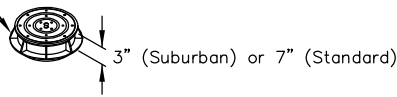

GRADE RING

2" = 80 lbs.
3" = 120 lbs.
4" = 165 lbs.
6" = 245 lbs.
12" = 490 lbs.

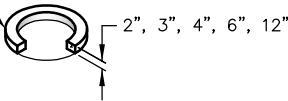

FLAT TOP

(Other Hole Sizes and Configurations Available)
13,890 lbs.

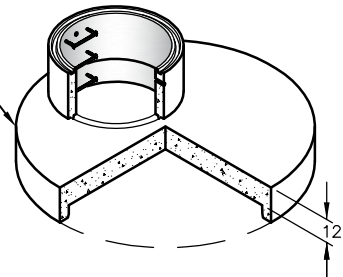

RISER

Outside Height	Weight
2'-0"	7,720 lbs.
3'-0"	11,590 lbs.
4'-0"	15,450 lbs.
5'-0"	19,310 lbs.
6'-0"	23,170 lbs.
7'-0"	27,030 lbs.
8'-0"	30,890 lbs.

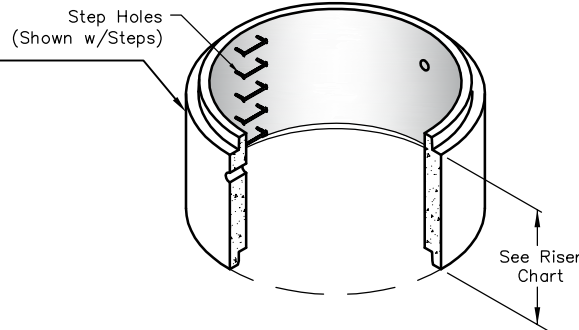

BASE

Nominal Height	Weight
2'-0"	20,130 lbs.
3'-0"	23,990 lbs.
4'-0"	27,850 lbs.
5'-0"	31,710 lbs.
6'-0"	35,570 lbs.
7'-0"	39,440 lbs.
8'-0"	43,300 lbs.

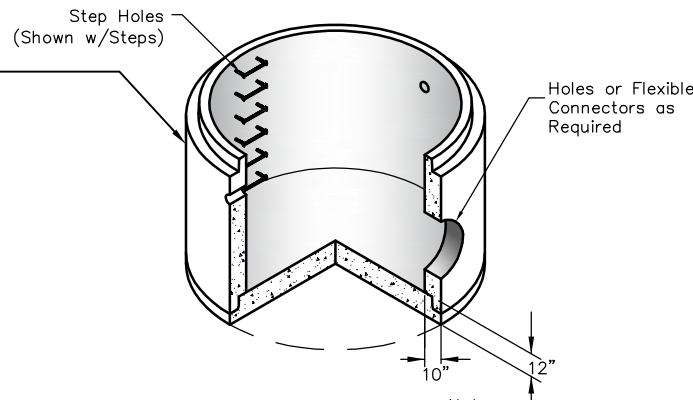

Notes:

- Manholes per Specification: ASTM C478
- Rubber Gasket: ASTM C443
- Holes: Cored or Cast as Required.
- Steps: Copolymer Polypropylene Plastic w/#4 Bar in Center.
- Frame & Cover: Gray Cast Iron ASTM A48 Class 30, Watertight/Tamperproof Cover Available.
- Optional Extended Base Available.



PO Box 323, Wilsonville, Oregon 97070-0323
Tel: (503) 682-2844 Fax: (503) 682-2657

108" MANHOLE

File Name: 020-108MH

Issue Date: 2017

oldcastleprecast.com/wilsonville

108" MANHOLE