

5106-2-TCA

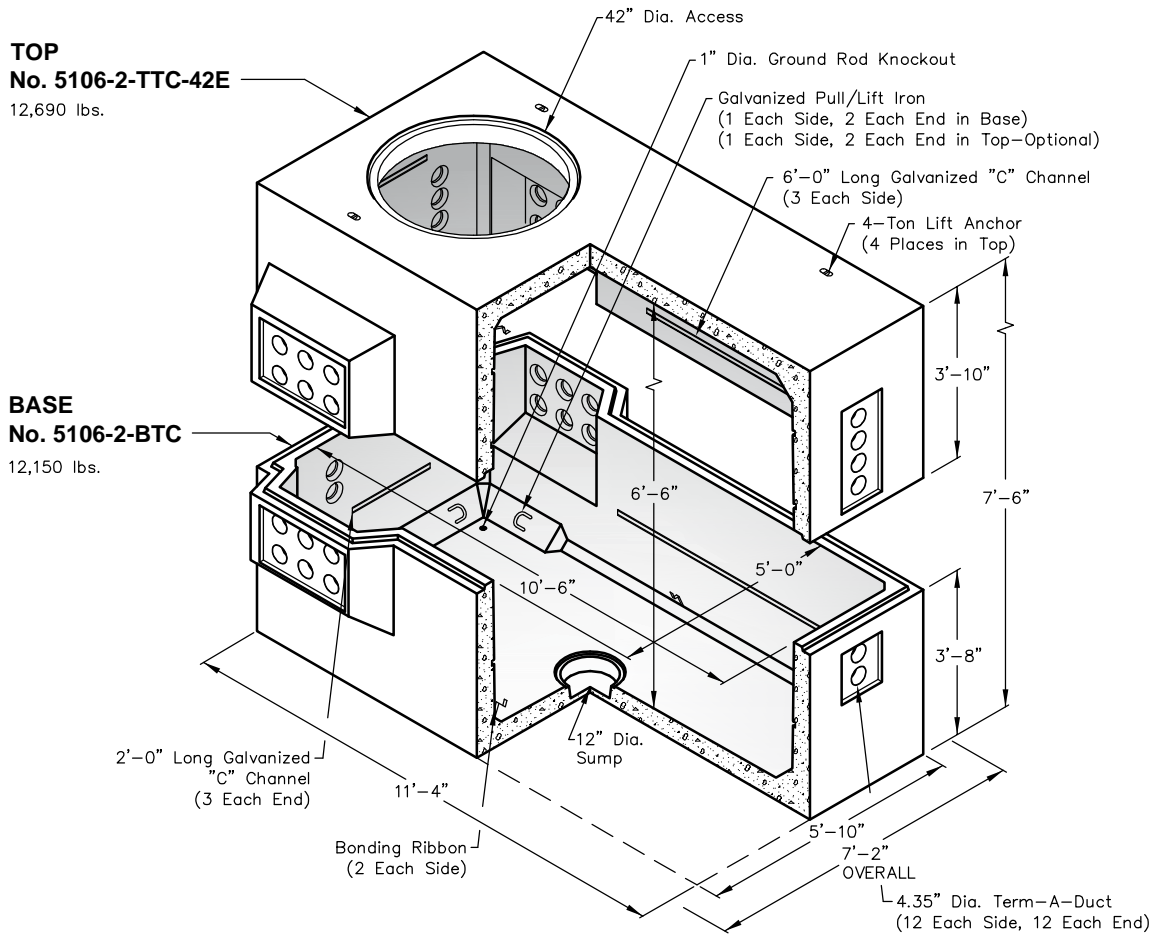

OPTIONAL
- Additional Term-A-Ducts
Located as Required.

OPTIONAL TOPS

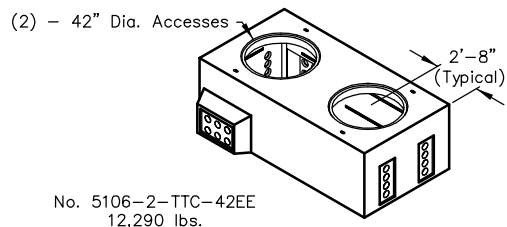
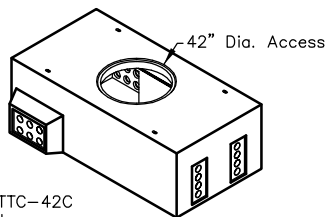

Note: Designed for 0 to 5'-0" of Cover

 <p>PO Box 323, Wilsonville, Oregon 97070-0323 Tel: (503) 682-2844 Fax: (503) 682-2657</p>	<h3>5106-2-TCA</h3>	<h3>5106-2-TCA</h3> <h3>5 x 10 - 2 PC.</h3> <h3>COMMUNICATIONS</h3>
	File Name: 020-5106TCA2	
	Issue Date: 2016	
	oldcastleprecast.com/wilsonville	

5106-2-TCA

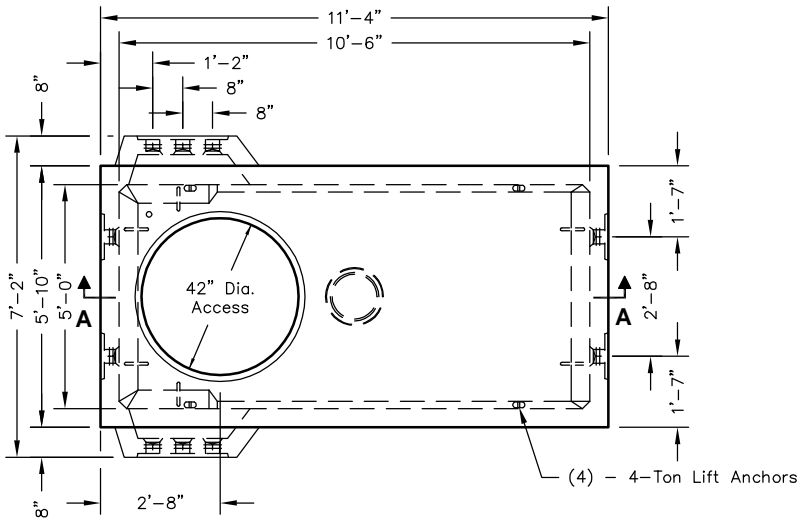

PLAN VIEW

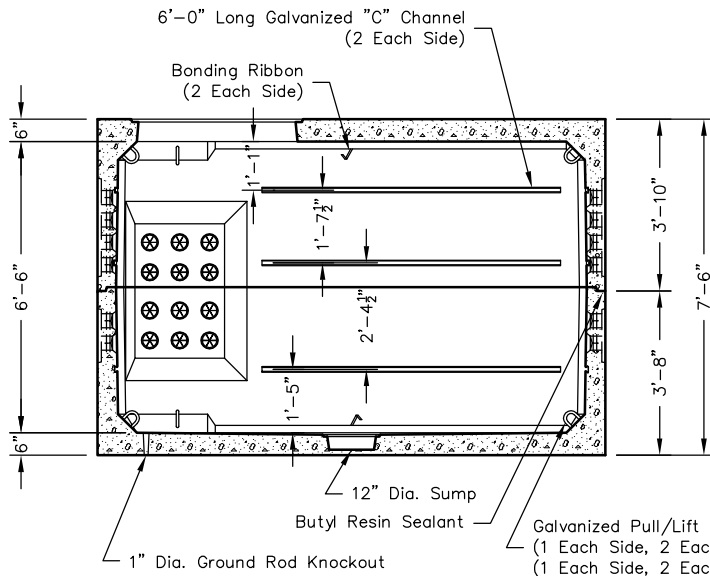

SECTION AA

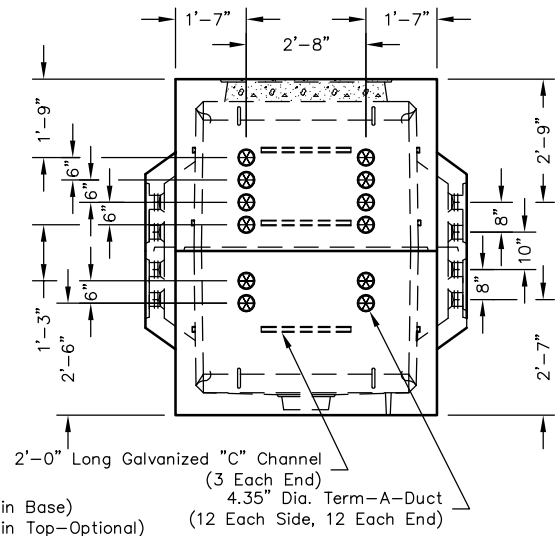

END VIEW

 <p>PO Box 323, Wilsonville, Oregon 97070-0323 Tel: (503) 682-2844 Fax: (503) 682-2657</p>	<p>5106-2-TCA</p>	<p>5106-2-TCA 5 x 10 - 2 PC. COMMUNICATIONS</p>
	<p>File Name: 020-5106TCA2</p>	
	<p>Issue Date: 2016</p>	
<p>oldcastleprecast.com/wilsonville</p>		