

**EXTENSION
 NO. 612-5X**
 14,300 Lbs.

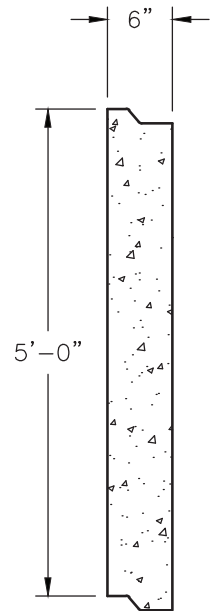
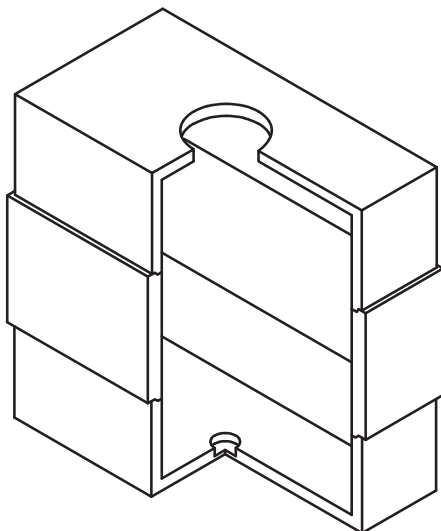
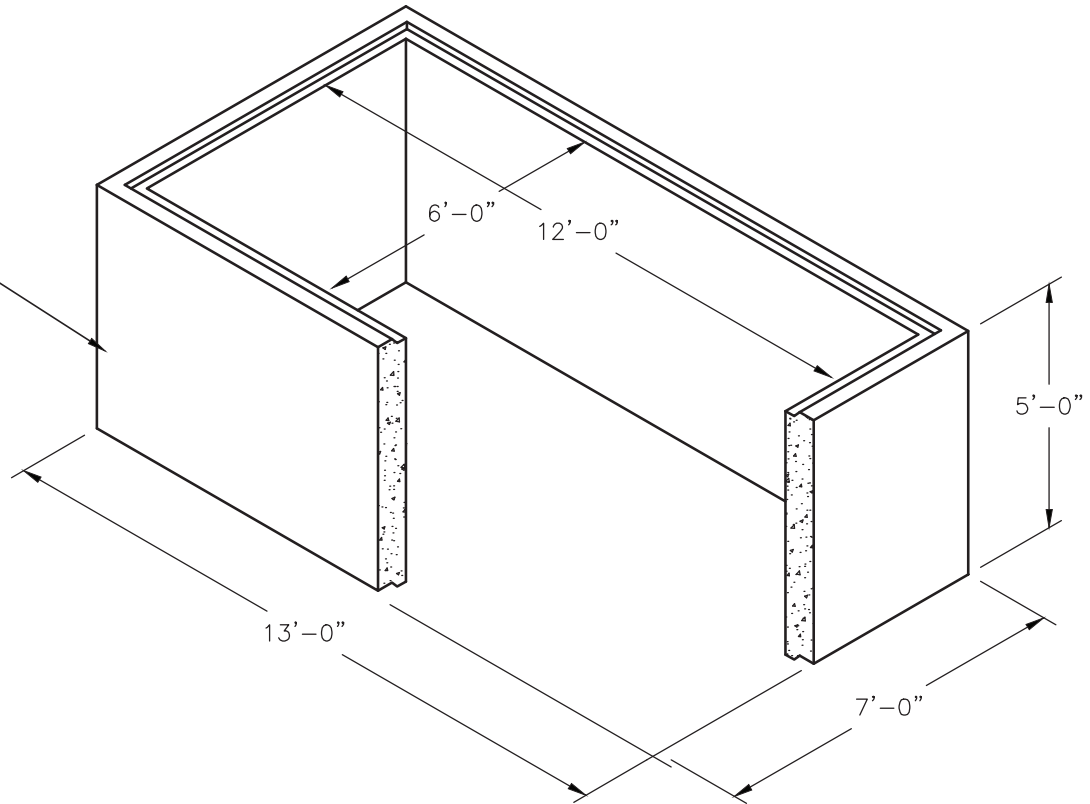

SECTION