

**EXTENSION
 NO. 615-3X**
 13,400 Lbs.

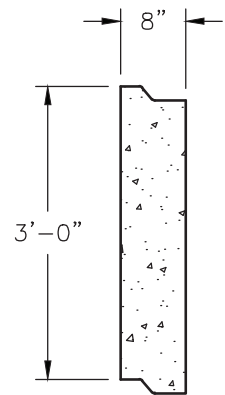
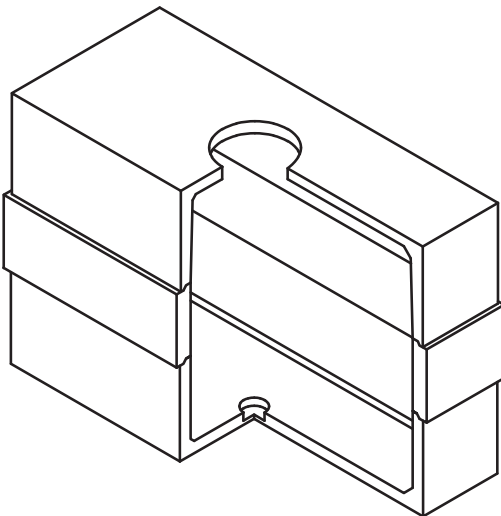
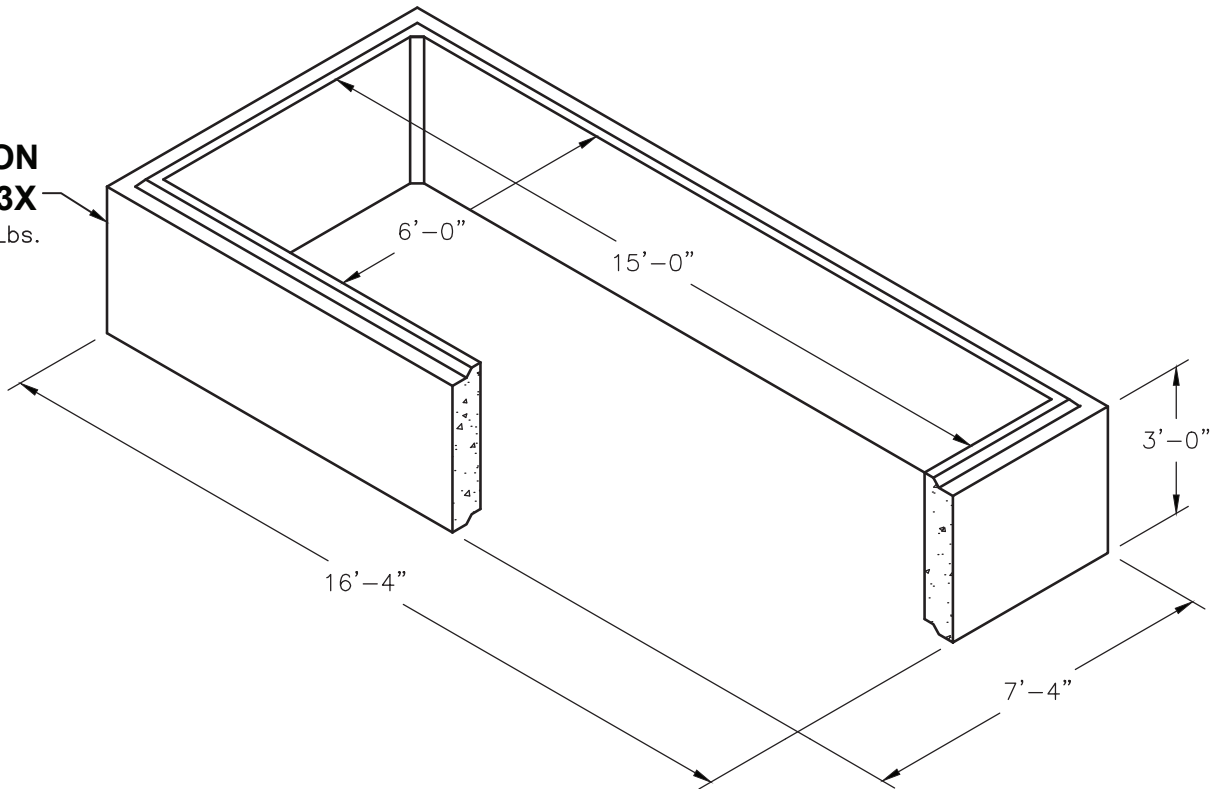

SECTION