

Ring and Cover

As Specified

Grade Rings

24" Keyed or Blunt

Eccentric Cone

Height=2'-8"

Lifting Hooks

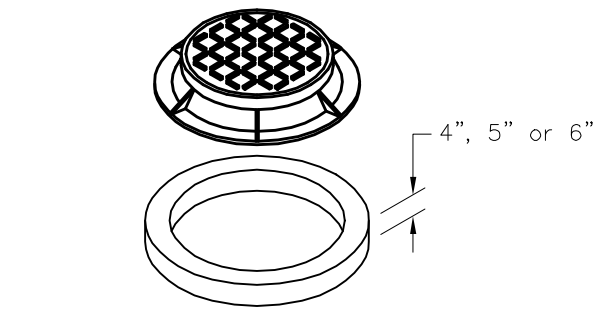

Riser Section

Standard Height:
1'-4" Multiples

Lifting Hooks

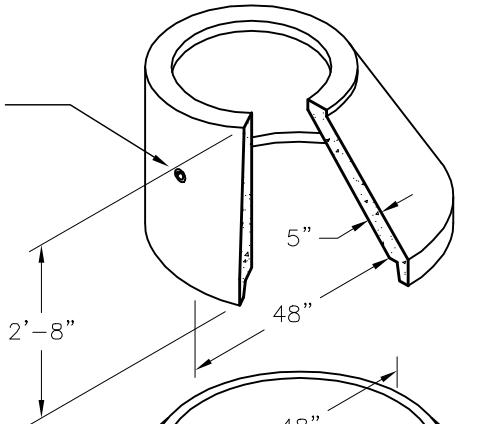

**Base Riser
w/Integral Base Slab**

Field Cast Invert

Lifting Hooks

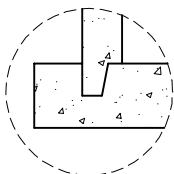
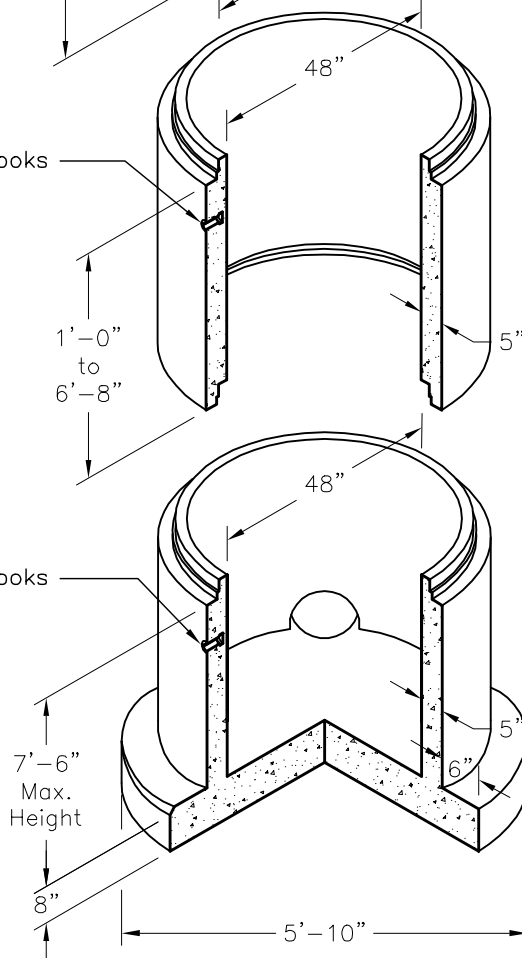

**Alternate Design
Manufactures Option**



**Oldcastle Precast®
Vanguard**

5230 N.W. 17th Street, Topeka, KS 66618
Phone: 785.232.2982 Fax: 785.232.5842

48MHEC32

FILE NAME: 120DMM48MHEC32_ISO

ISSUE DATE: January 2007

www.vanguardprecast.com

**Standard 48" ID Manhole
2'-8" Eccentric Cone**

Copyright © 2007 Oldcastle Precast