

PLAN VIEW
SCALE: 3/4" = 1'-0"

WEIGHTS	
SECTION	WEIGHT
TOP SLAB	1,100 LBS
BASE SECTION	3,300 LBS
TOTAL	4,400 LBS

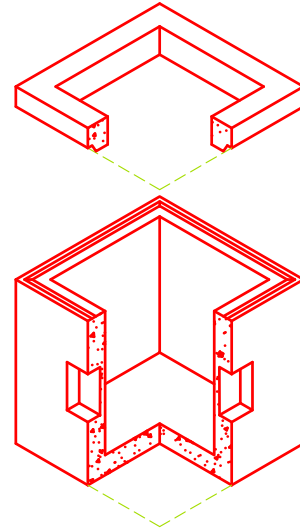

ISO VIEW
SCALE: 1/4" = 1'-0"

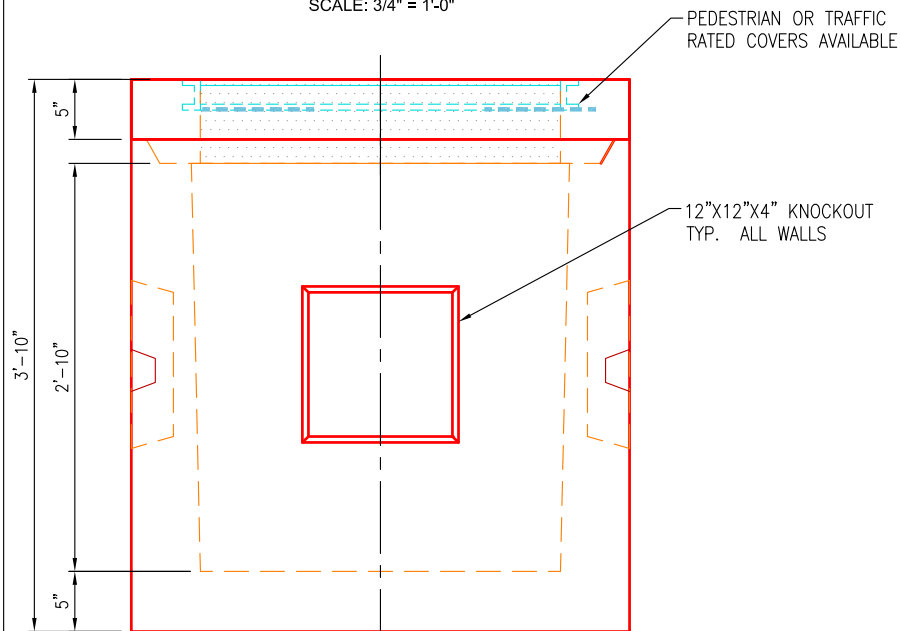

SIDE VIEW
SCALE: 3/4" = 1'-0"

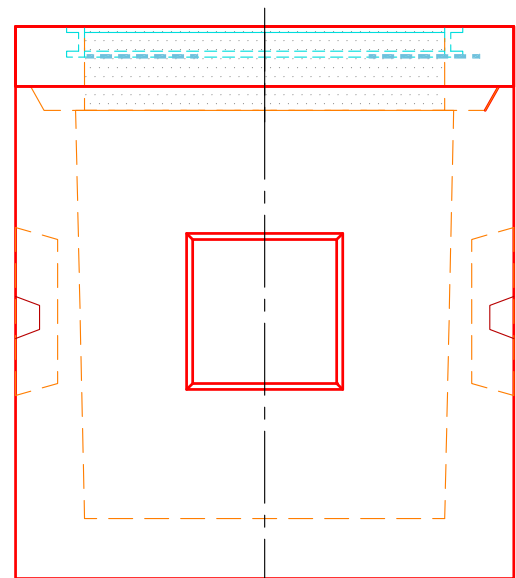

END VIEW
SCALE: 3/4" = 1'-0"

SPECIFICATIONS:

- Concrete minimum compression strength:
F'c=5,000 PSI @ 28 days.
- Reinforcing steel: ASTM A615, Fy=60,000 PSI

ITEMS ARE SUBJECT TO CHANGE WITHOUT NOTICE.