

1'-0" of Riser

Weight: 1,960 lbs.

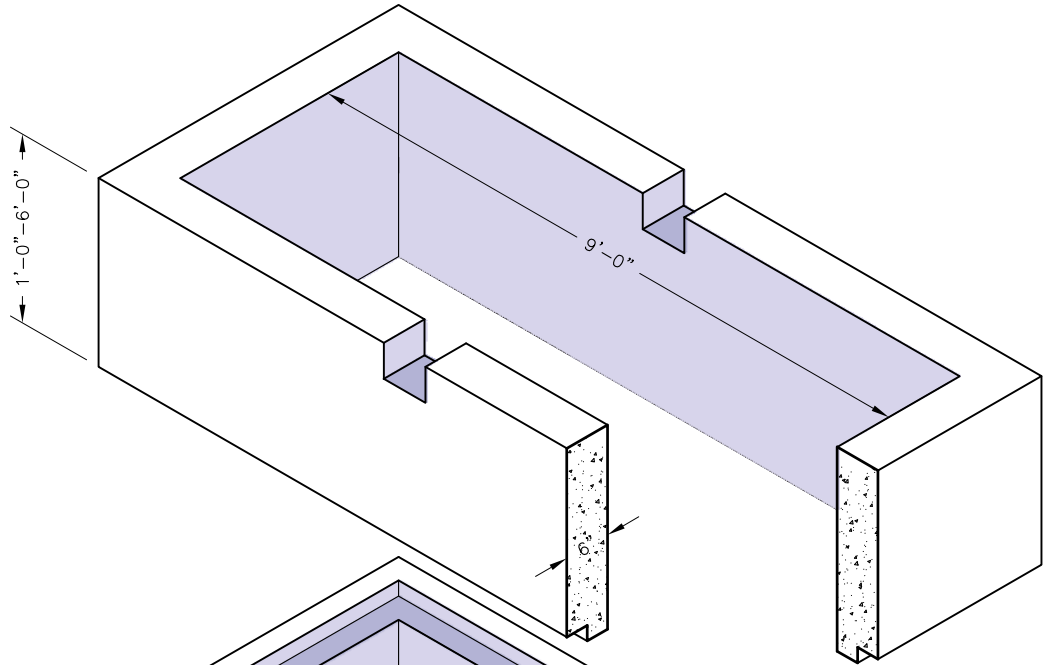

Base Slab

Weight: 4,820 lbs.

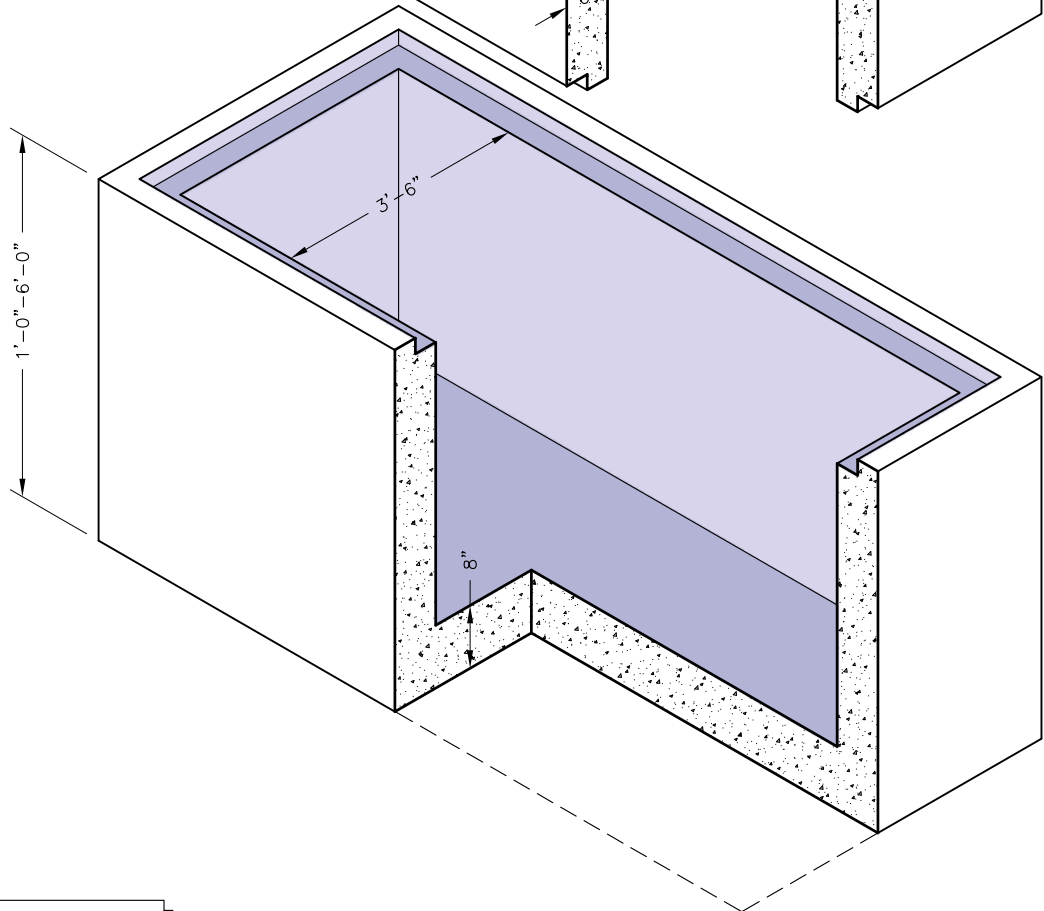

SPECIFICATIONS:

1. Concrete shall be 4000 PSI at 28 day compressive strength.
2. Structure conforms to ASTM C913-02.
3. Design: HS-25 traffic loading.

GENERAL NOTES:

1. Sections to be made in 6" increments.