

Oldcastle Precast[®]

GT-3000

FILE NAME: 324ECGGT3000_ISO.DWG

ISSUE DATE: January, 2008

www.oldcastleprecast.com

6'-0" x 14'-0" x 6'-0" I.D.
Grease Trap
3,000 Gallon Capacity

Copyright © 2008 **Oldcastle Precast**[®]

NOTES:

1. Concrete : 5,000 P.S.I
Minimum Strength @ 28 Days
2. Steel Reinforcing- ASTM A-615,
Grade 60.
3. Cover to Steel-1" Minimum
4. Tanks are Designed to Meet ASTM
C858 and ACI 318 With AASHTO
HS-20 Loading
5. Earth Cover -0 to 5 Feet Max.
6. Construction Joint-Sealed with
1"Dia Butyl Rubber or Equivalent

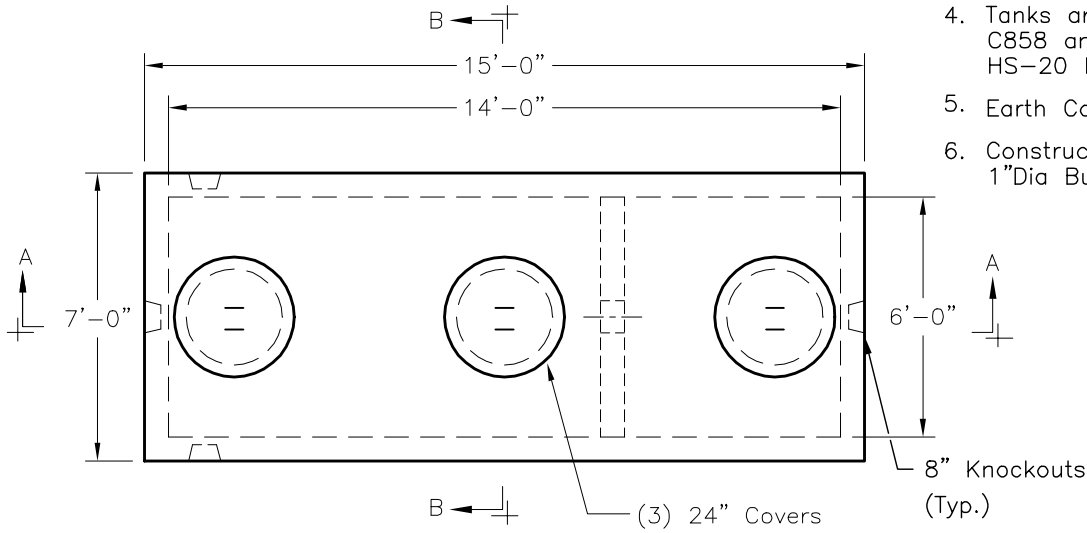

PLAN VIEW

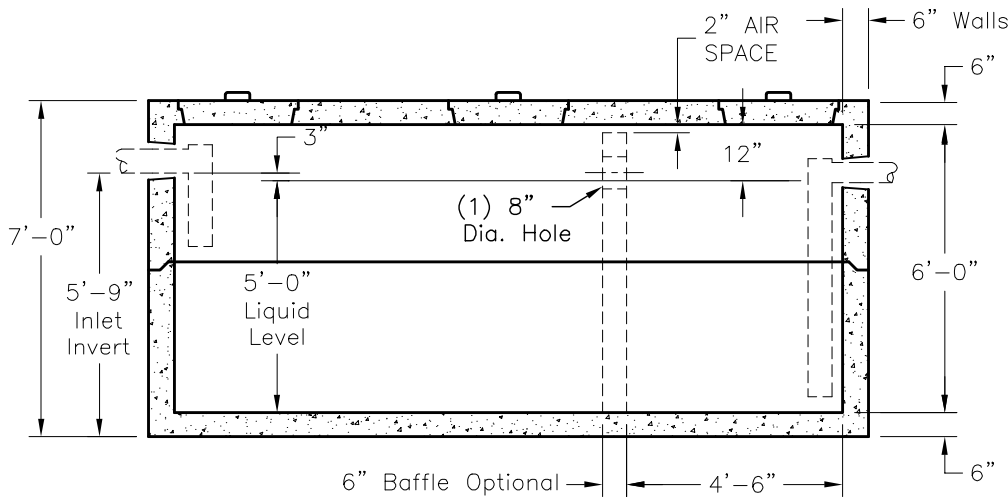

SECTION A-A

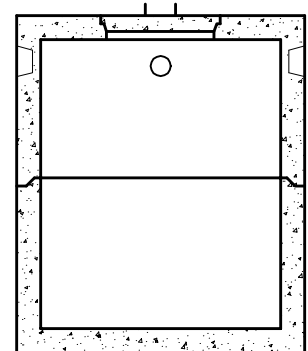

SECTION B-B



GT-3000

FILE NAME: 324ECGGT3000_DET.DWG

ISSUE DATE: January, 2008

www.oldcastleprecast.com

**6'-0" x 14'-0" x 6'-0" I.D.
Grease Trap
3,000 Gallon Capacity**

Copyright © 2008 **Oldcastle Precast**