

**TOP**

WT. Variable

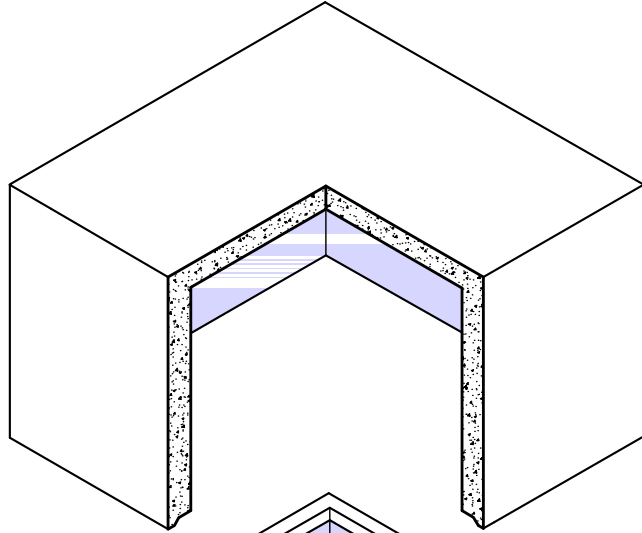

**BOTTOM**

WT. Variable

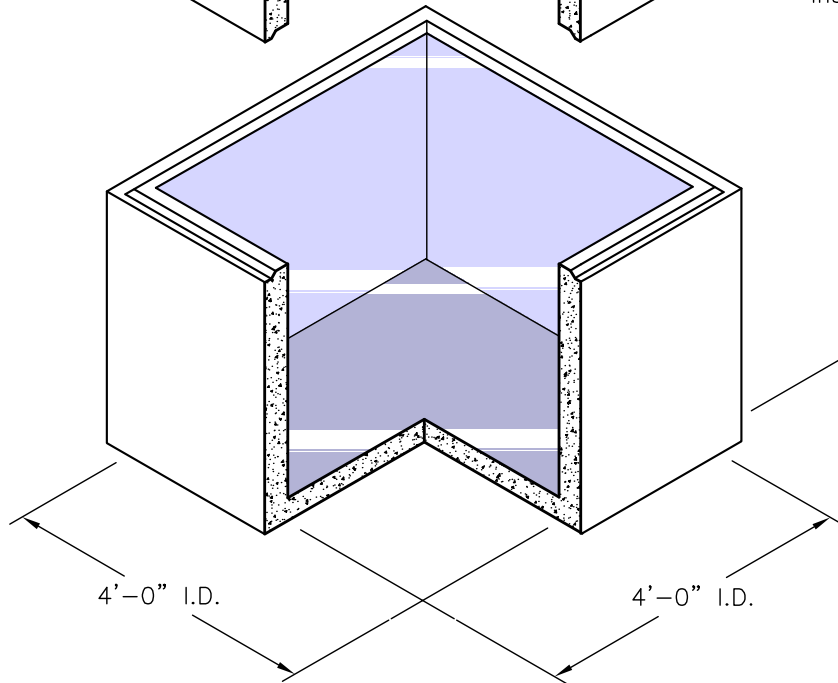

**SPECIFICATIONS:**

1. Inside Height as Specified.
2. Inside Roof, Floor and Side Wall Openings as Specified.
3. Maximum inside Height for 2 Piece Manhole 10'-4"
4. Maximum inside Height of Each Additional Piece 5'-2"