

COVER
24" Dia.

ROOF SLAB
1.6 Tons

BOTTOM
See Chart

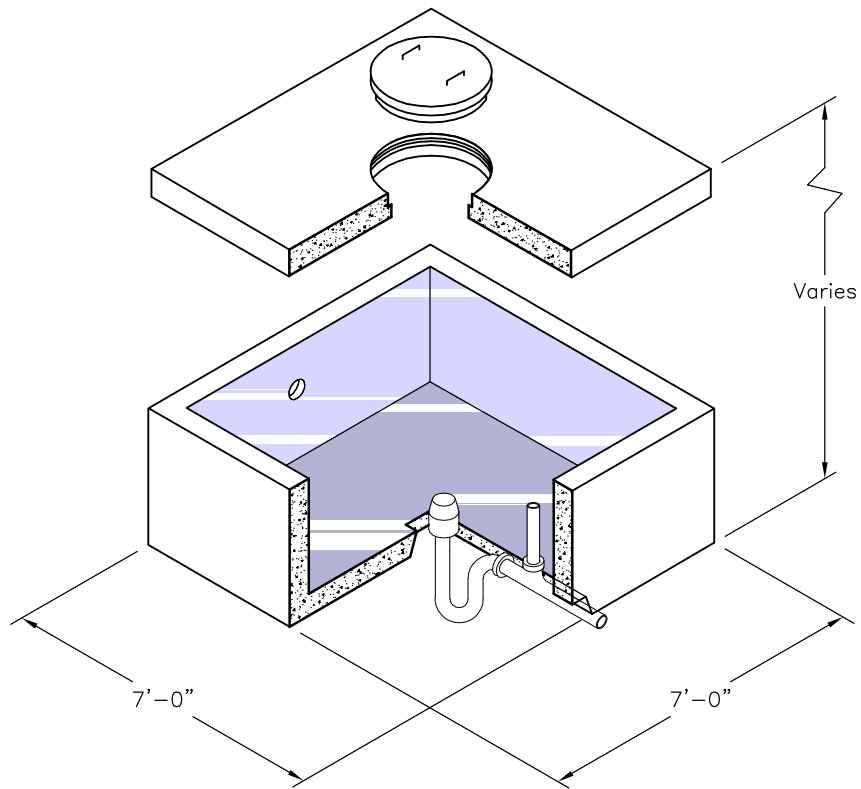

This Siphon Chamber is Available in Single or Double Alternating Models.