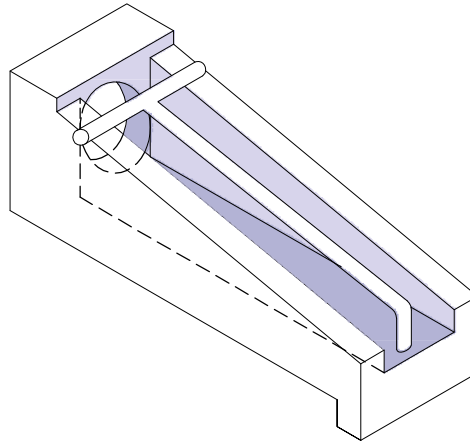
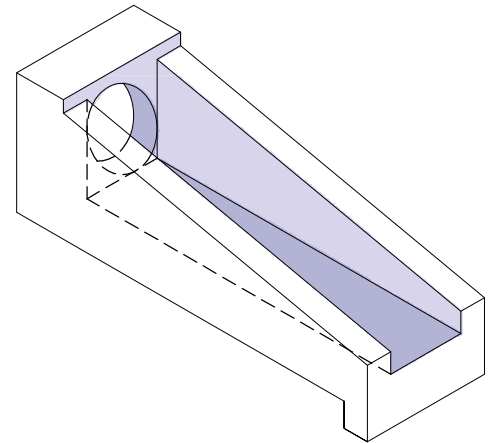
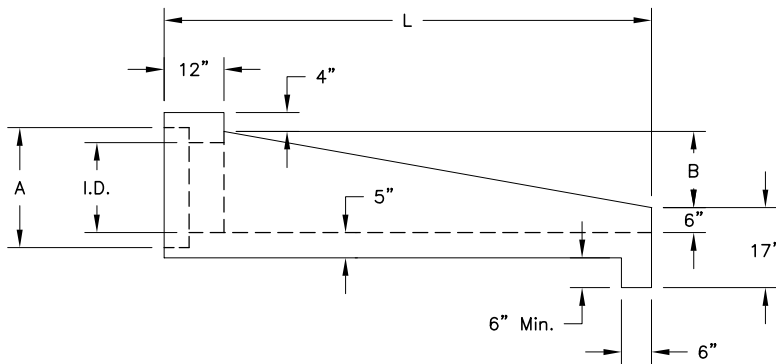
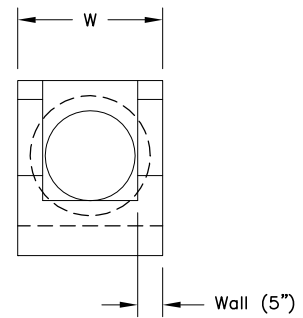

***TYPE II PARALLEL DRAINAGE**
"TYPE P"

***TYPE II CROSS DRAINAGE**
"TYPE C"

PLAIN

ELEVATION VIEW

END VIEW
SPECIFICATIONS:

1. Concrete: Class "C" with design strength of 3600 PSI at 28 days.
2. Steel reinforcement: ASTM A-615 Grade 60.
3. Reinforcement: #4 @ 9" O.C. ea way or wire mesh equivalent to 0.24 in / linear foot in each direction.
4. Galvanized pipe shall conform to TXDOT specifications.

Pipe I.D.	Slope	Weight	W	L	A	B
24"	3 : 1	2,710 Lbs.	34"	78"	31"	22"
	4 : 1	3,345 Lbs.	34"	100"	31"	22"
	6 : 1	4,620 Lbs.	34"	144"	31"	22"