

***TYPE II PARALLEL DRAINAGE**
"TYPE P"

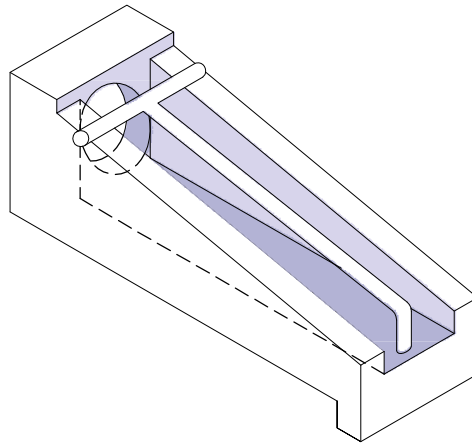

***TYPE II CROSS DRAINAGE**
"TYPE C"

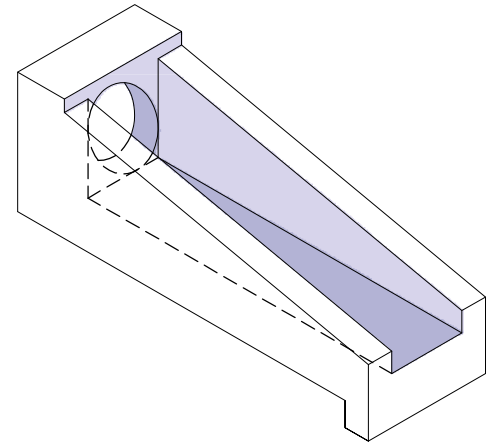

PLAIN

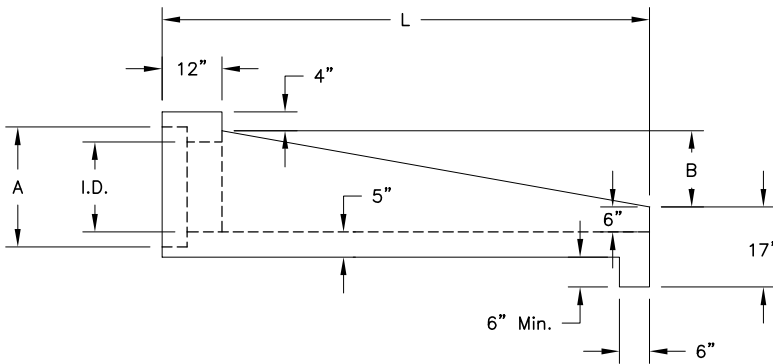

ELEVATION VIEW

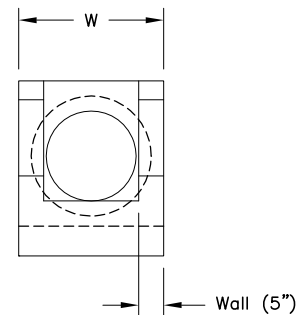

END VIEW

SPECIFICATIONS:

1. Concrete: Class "C" with design strength of 3600 PSI at 28 days.
2. Steel reinforcement: ASTM A-615 Grade 60.
3. Reinforcement: #4 @ 9" O.C. ea way or wire mesh equivalent to 0.24 in / linear foot in each direction.
4. Galvanized pipe shall conform to TXDOT specifications.

Pipe I.D.	Slope	Weight	W	L	A	B
30"	3 : 1	4,015 Lbs.	40"	99"	38"	29"
	4 : 1	5,015 Lbs.	40"	128"	38"	29"
	6 : 1	7,015 Lbs.	40"	186"	38"	29"