

ALL CONCRETE SHALL HAVE A 28 DAY COMPRESSIVE STRENGTH OF 4500 psi.

REINFORCING STEEL SHALL COMPLY WITH ASTM A615 GRADE 60, A706 GRADE 60 OR A497 GRADE 70. BAR BENDING AND PLACEMENT SHALL COMPLY WITH THE LATEST ACI STANDARDS

STANDARD STRUCTURAL DESIGN IS BASED ON AASHTO HS 20 WHEEL LOADING

WATER TABLE IS AT 3'-0" BELOW GRADE FOR STANDARD STRUCTURAL DESIGN

THE STANDARD DESIGN IS BASED ON THE TOP AT ANY ELEVATION BETWEEN FINISHED GRADE AND 5'-0" BELOW GRADE. THE STRUCTURE SHALL BE PLACED ON A COMPACTED GRANULAR BASE TO INSURE UNIFORM DISTRIBUTION OF SOIL PRESSURES.

SPECIAL DESIGNS BASED ON OTHER LOADINGS OR DEEPER INSTALLATION DEPTHS ARE AVAILABLE ON REQUEST. KNOCKOUTS, OR PIPE OPENINGS CAN BE PROVIDED IN THE SIZE AND LOCATIONS REQUIRED.

INSERTS, PULLING IRONS OR SUMPS CAN BE SUPPLIED AS REQUESTED.

TOP SECTION

PERSONNEL OPENING SIZE OR CAST IN RING AND COVER AS REQUIRED BY CUSTOMER SEE NECK EXTENSION AND COVER DETAILS FOR FEATURES AVAILABLE.

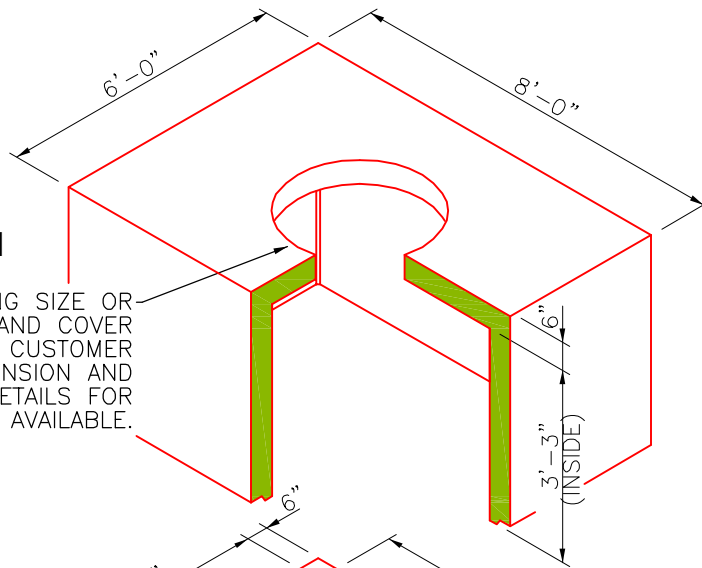

APPROXIMATE TOP OR BOTTOM WEIGHTS 3'-3" INSIDE 10000 LBS.

BOTTOM SECTION

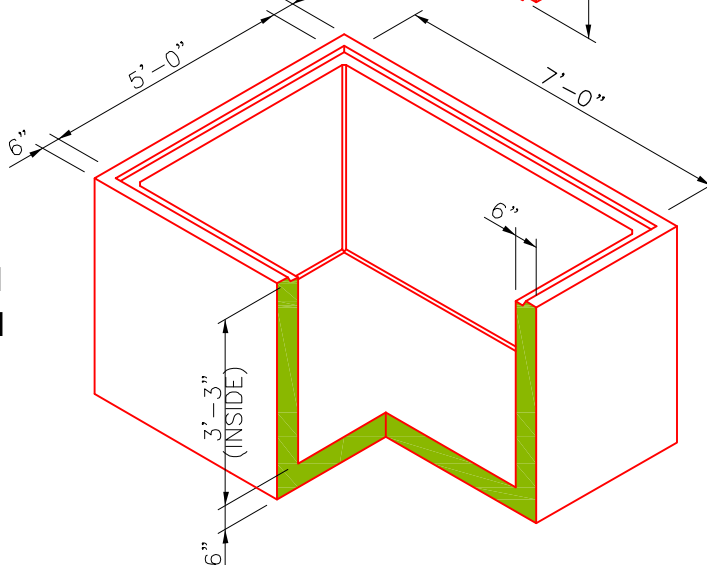

MINIMUM EXCAVATION 8'-0"x10'-0"



Oldcastle Precast

1900 Rilling Road San Antonio, TX 78214
Phone: (210) 923-4523 Fax: (210) 921-0473

57-M

FILE NAME: 57M2TE.dwg

ISSUE DATE: March, 2005

www.oldcastlesanantonio.com

**5'-0"x7'-0"x6'-6"
2-PIECE MANHOLE**

Copyright 2005 Oldcastle Precast All Rights Reserved