

SHIP-LOOSE ITEMS		
QTY	DESCRIPTION	ITEM ID
3 ROLLS	JOINT SEALANT 1" x 14.5' CS-102	5439200
OLDCASTLE ID		
QTY	DESCRIPTION	ITEM ID
1 EA.	6 x 12 x 3 TOP SECTION	1902335
1 EA.	6 x 12 x 5 BASE SECTION	0120850
1 EA.	6 x 12 3300 GAL. BAFFLE WALL	1902330
1 EA.	BAFFLE WALL INSTALLATION	1902311

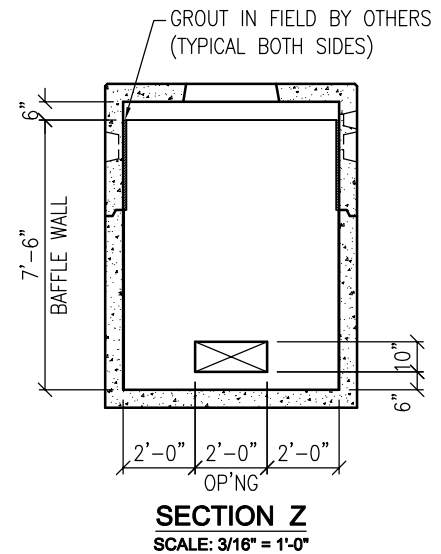

GENERAL NOTES:

1. CONCRETE: F_c = 5,000 psi.
2. REINFORCING STEEL: ASTM A-615, F_y = 60 ksi
3. DESIGN LIVE LOAD = HS-20
4. EARTH COVER = 0'-0" MIN. TO 2'-0" MAX.
5. BUTYL RUBBER JOINT SEALANT
6. GRAY WATER ONLY
7. BLACK WATER SHALL BE CARRIED BY SEPARATE SIDE SEWER
8. CONTRACTOR TO:
 - SUPPLY & INSTALL ALL PIPING & SAMPLING TEES
 - KNOCKOUT OPENINGS AS NEEDED & GROUT IN ALL PIPES & WEIRS
 - FILL w/ CLEAN WATER PRIOR TO "START UP" OF SYSTEM
 - VERIFY SIZE & LOCATION OF ALL OPENINGS

WEIGHTS:

TOP SECTION: 7.36 TONS / 14,713 LBS.
 BASE SECTION: 10.40 TONS / 20,792 LBS.
 BASE SECTION w/ BAFFLE: 11.47 TONS / 22,938 LBS.



Oldcastle Precast[®]
CHESAPEAKE

1401 TRIMBLE ROAD
 EDGEWOOD, MD 21040 410-812-1213
 5115 MASSAPONAX CHURCH ROAD
 FREDERICKSBURG, VA 22407 540-898-6300

OPI-CHESAPEAKE-INFO@OLDCASTLE.COM

GI-6128

FILE NAME: 365GT3300GA.DWG

ISSUE DATE: October, 2017

SCALE: 1/4" = 1'-0"

Grease Interceptor
6'-0" x 12'-0" x 8'-0" I.D.
3300 Gallon Capacity

Copyright © 2017 Oldcastle Precast, Inc.

