

STAKAKbox™

ULTIMA Connect

Installation Guide

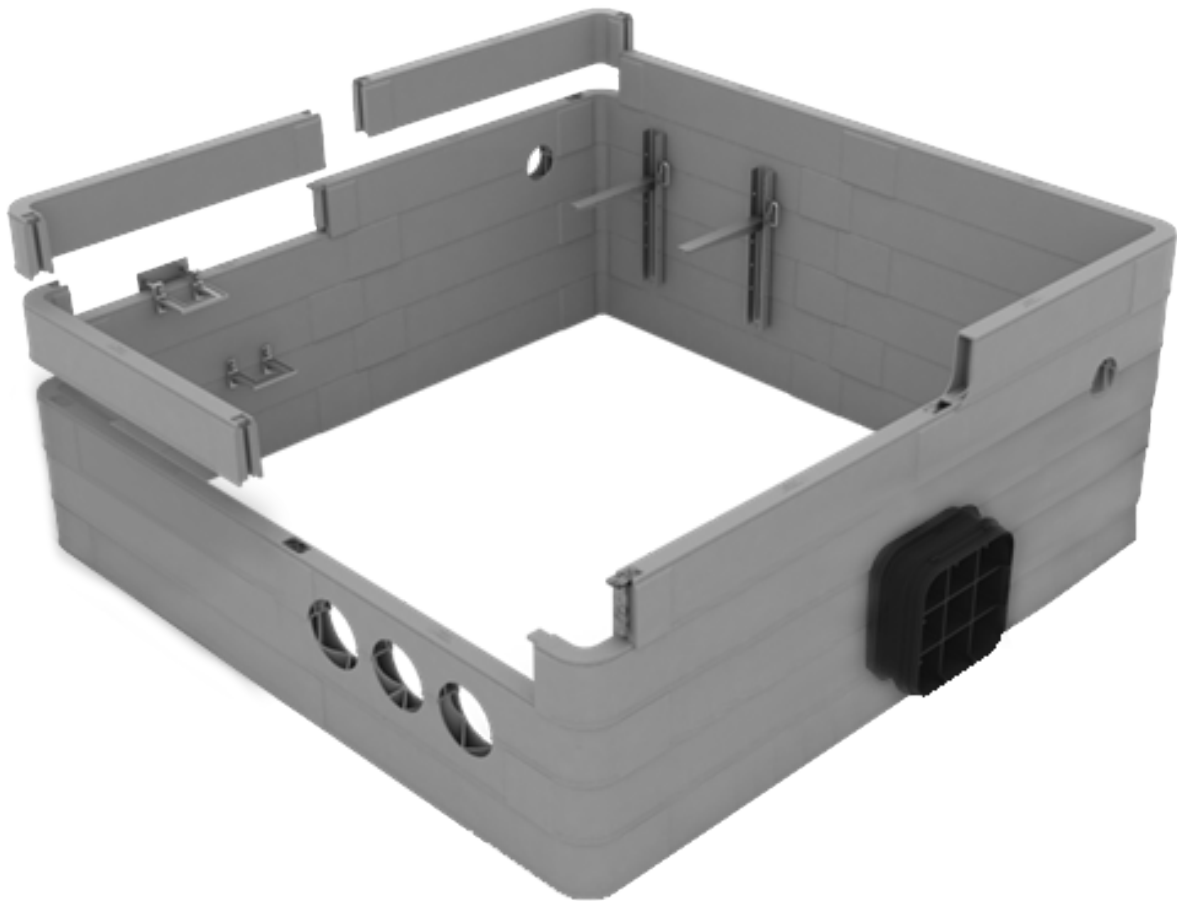

Table of Contents

Introduction	2	Trench Connections	8
Product Overview	2	Overbuilding Existing Services	9
Frame & Cover Options	4	Wall Accessories & Cable Management	10
Equipment and Additional Materials	4	Backfill Bracing	11
Footprint	5	Chamber Backfill	12
Excavation	5	Depth Adjustment	13
Foundation	5	Frame & Cover Installation	14
Chamber Assembly	5	Slab Installation	16
Duct Entries	6	Ground Level Reinstatement	17
MULTIduct™ Connections	7	Notes	18

1. Introduction

This guide addresses the method and detail for the installation of the STAKKAbox™ ULTIMA Connect access chamber system. The purpose is to serve as a guideline, and is not intended for any specific construction project.

It is understood there are alternative ways that might be required and/or recommended based on site or project conditions. Oldcastle Infrastructure reserves the right to alter these guidelines and encourages contact with the business or its representatives to review any possible modification to these notes prior to commencing installation.

2. Product Overview

The STAKKAbox ULTIMA Connect is a modular scalable solution which can be delivered pre-built or can be built on-site with easily connectible components. STAKKAbox ULTIMA Connect corner components are manufactured in left and right ‘handed’ designs, which offer the ability to offset joints between ring sections in order to provide a brick-worked design.

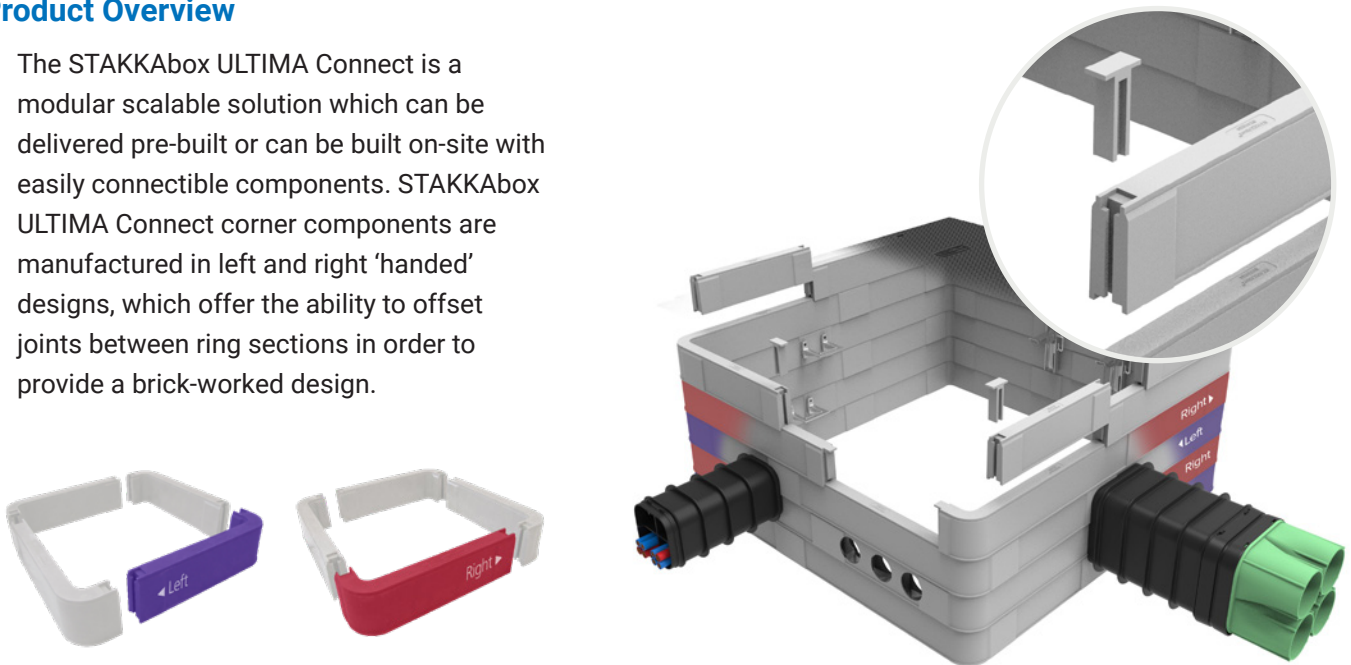

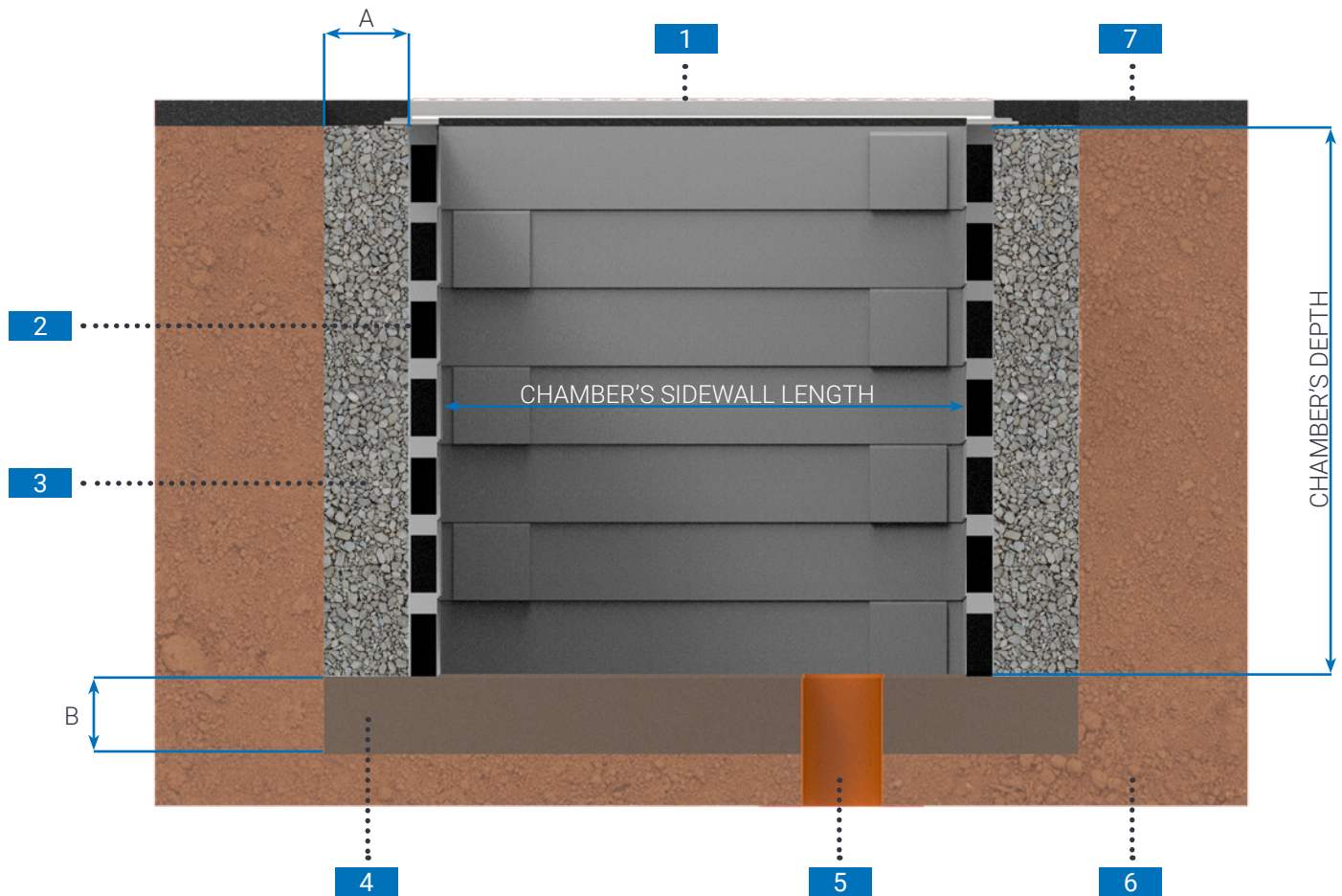

	Items	Notes
1	Frame & Cover	Dimensions to suit project specification
2	STAKKAbox ULTIMA Connect Chamber	Dimensions to suit project specification Chamber's sidewall length and depth
3	Backfill	See Table 1 (Material Type / Width of Backfill) above for material and dimension A
4	Base	See Table 1 (Base Material) above for material and dimension B
5	Drainage Soakaway	Optional
6	Existing Ground	
7	Surface Material	

3. Frame and Cover Options

Oldcastle Infrastructure manufactures a range of frames and covers engineered to work seamlessly with the STAKKAbox ULTIMA Connect access chambers. If a frame and cover is being installed, it must be specified to the correct loading as dictated by the load rating and site requirements.

- A standard frame and cover is built-to-order with welded corners, galvanized steel beams and composite covers.
- A MODUcover is made of in-stock components assemble on-site with aluminum extrusions, mechanical connections, galvanized steel beams and composite covers.
- A precast concrete slab can be customized to interface with surface mounted equipment.
- A recessed frame accepts paver stones for use in decorative applications.

If you have any questions, please contact Oldcastle Infrastructure.

Standard Frame and Cover

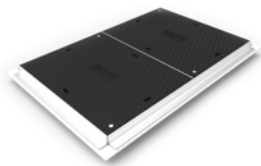

MODUcover Frame and Cover

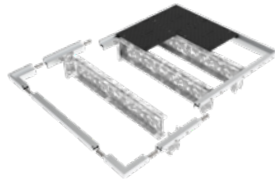

Precast Concrete Slab



Recessed Frame

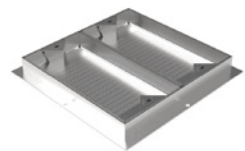

4. Equipment and Additional Materials

In addition to the STAKKAbox ULTIMA Connect, in order to complete an installation you will need the following:

- The means of excavating a hole; mechanical digger, pneumatic hammer etc. depending on the ground conditions and size of chamber being installed
- Shovel or spade
- Means of compacting base and surrounding material
- Builders trowel
- Straight edge/level
- Hammer or weighted mallet

Materials Required:

- Base materials
- Backfill material
- Bedding mortar
- Bracing if required

If Cutting a Chamber, the Below are Required:

- Dust Mask
- Hole Saw
- Saw or Disk Cutter
- Power Drill

5. Footprint

- 5.1. Mark the extremity of the excavation on the ground.

6. Excavation

- 6.1. Excavate to the correct depth.
 - a. Consider the depth of the base, frame, and bedding mortar.

7. Foundation

- 7.1. Compact the bottom of the excavation.
 - a. Remove soft areas, fill with suitable materials, and compact.^[1]
- 7.2. Construct the chamber foundation.
 - a. Install drainage if required.
- 7.3. Construct^[3] and place the bottom ring section on the base.
 - a. Where possible key in bottom ring into the base.
 - b. Ensure the ring section is level.

8. Chamber Assembly

- 8.1. Construct the remainder of the chamber.^[3]

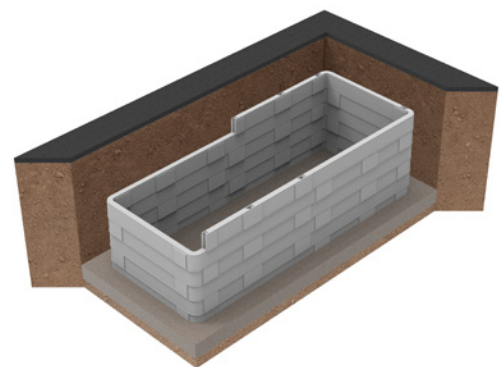
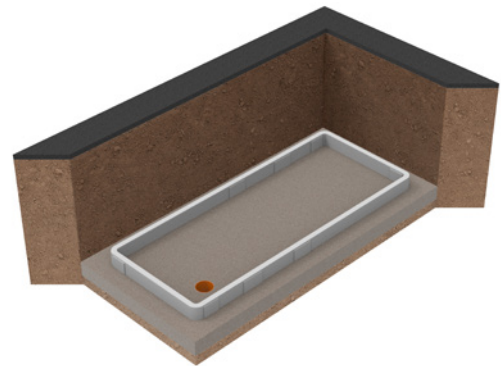
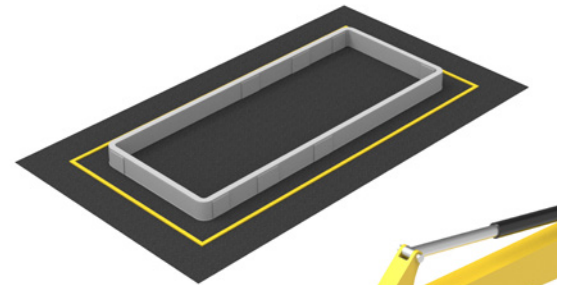

9. Duct Entries

9.1. Guideline restrictions when forming duct entries are shown below. Contact Oldcastle Infrastructure to provide guidance on duct entries which exceed these restrictions.

- a. Duct entries can be preformed in an Oldcastle Infrastructure factory or formed on site.
- b. Site formed duct entries can be formed by two methods. Using a hole saw^[2] (A) or using a saw to form a rectangular opening. (B)
 1. If required duct entries can be cut across two or more sections.

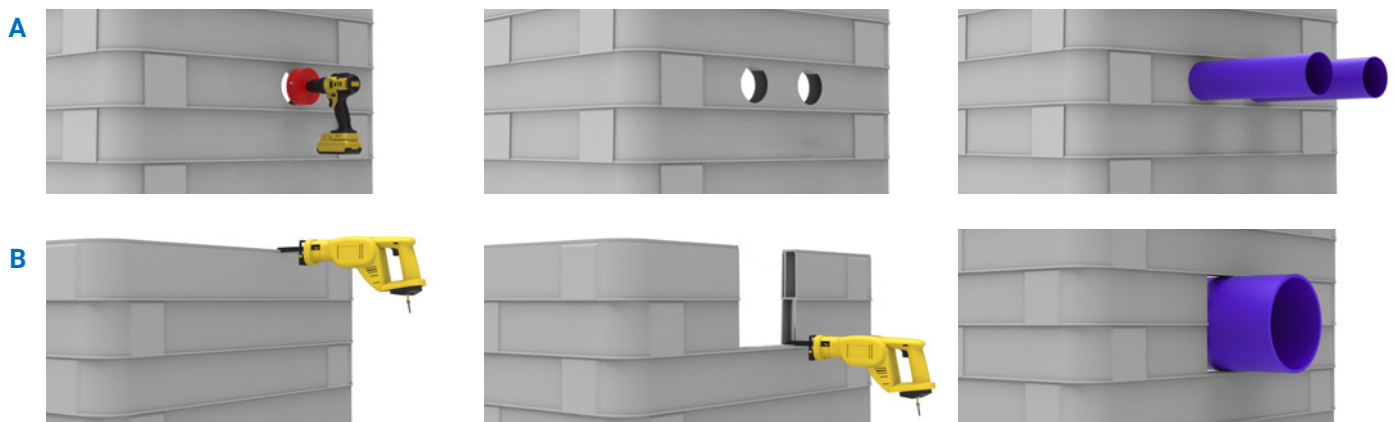

9.2. Duct entries up to 5 inches in diameter can be drilled in every ring section but the top and bottom ring sections of the chamber should be left intact. (C)

9.3. As a rule of thumb allowable distance between ducts should be half of the diameter of the largest duct entry. (D)

9.4. Insert ducts.

- a. Fill gaps as per site requirement to prevent backfill from entering.

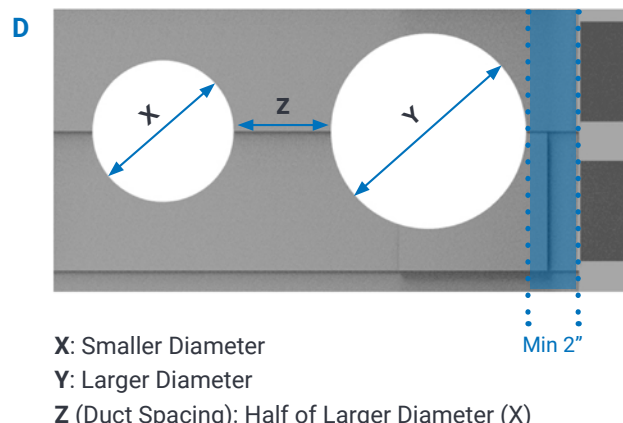
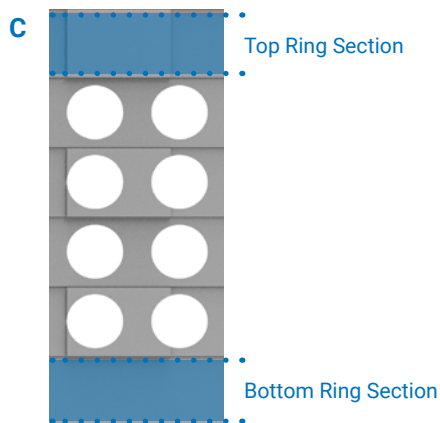

10. MULTIduct™ Connections

10.1. Guideline restrictions when forming MULTIduct connections are shown below. Contact Oldcastle Infrastructure to provide guidance on MULTIduct connections which exceed these restrictions.

- a. MULTIduct connections can be preformed and fixed in an Oldcastle Infrastructure factory or formed and fixed on site.
 1. Factory formed connections are supplied with an installed spigot or socket connection which is ready to plug into a MULTIduct run.
- b. Site formed connections can be formed by two methods.
 1. Using a hole saw^[2] and power drill to form four round corner openings, then cutting out the remainder using an electric saw. (A)
 2. Using an electric saw to form a rectangular opening. (B)

10.2. Where possible the ring sections above and below the MULTIduct should remain intact.

10.3. Insert MULTIduct.

10.4. Fill gaps as per site requirement to prevent backfill from entering.



Minimum of 2" from internal edge of chamber

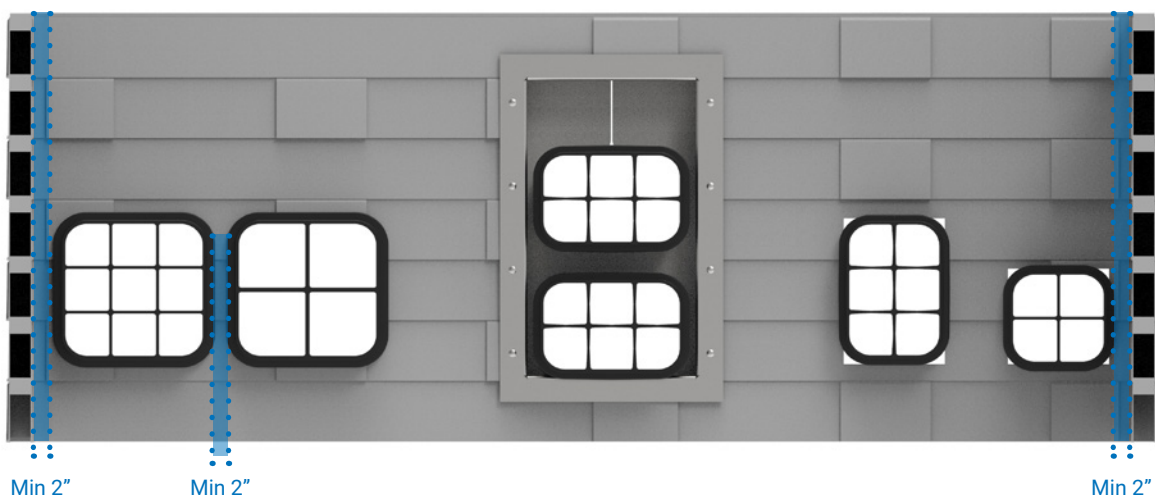

11. Trench Connections – Plastibeton® and PROtrough

11.1. Form trench connections if required

- a. Guideline restrictions when forming trench connections are shown below. Contact Oldcastle Infrastructure to provide guidance on trench connections which exceed these restrictions.

11.2. Site formed entries can be formed using a saw and/or a disk cutter to cut a rectangular opening in the chamber wall.

- a. Cut the trench body corner to fit the frame before inserting it in the chamber.
- b. Position the trench end so it is flush with the chamber inner wall.

11.3. Cut the trench and cover back so it is flush with the flange of the frame.

11.4. Fill gaps as per site requirement to prevent backfill from entering.

1

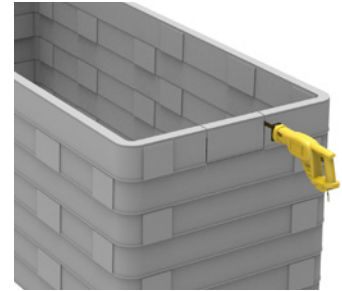

2

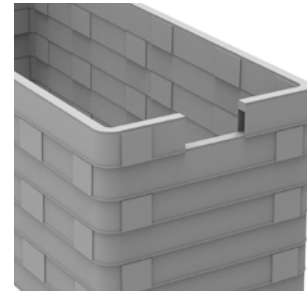

3

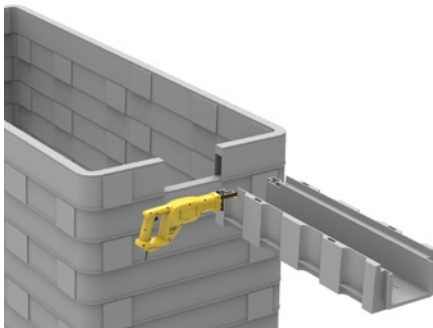

4

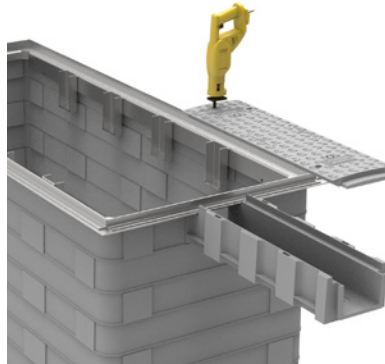

5



Finished PROtrough

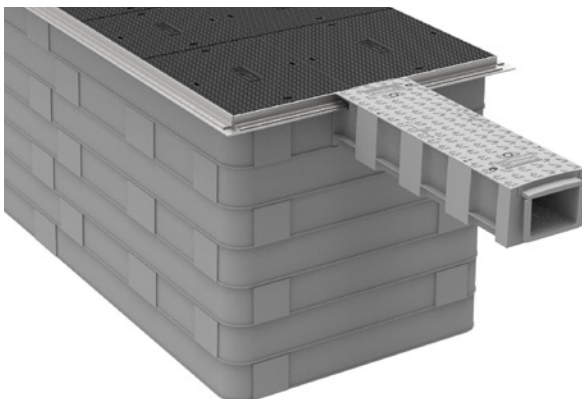

Finished Plastibeton®

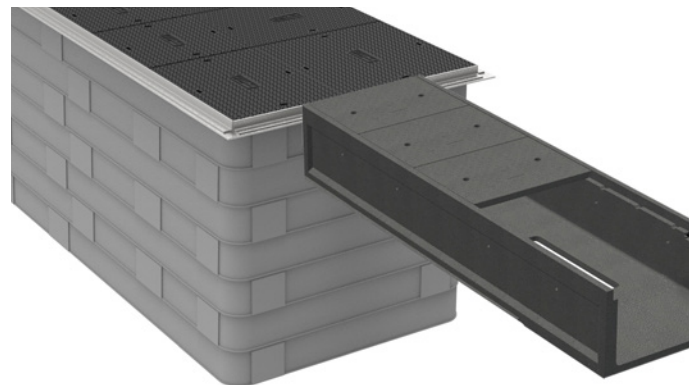

12. Overbuilding Existing Services

12.1. Alter chamber for existing services if required.

a. Use an appropriate cutting tool to form a typical duct entry, then cutting out below the duct entry using a saw to create an open-ended arch in a ring section.

1. Use an saw to form a rectangular opening.

12.2. Build the chamber over the services.

12.3. Fill gaps as per site requirement to prevent backfill from entering.

12.4. The top and bottom ring section of the chamber should be kept complete. However, deviations are permissible under certain circumstances. Please contact Oldcastle Infrastructure for further guidance.

Arched Cut Duct Entry

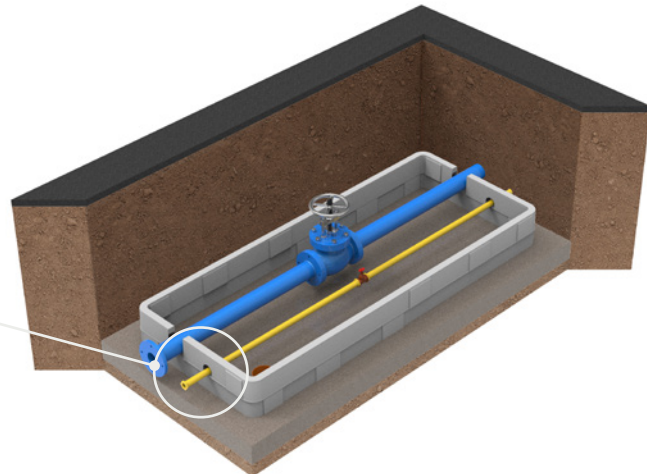
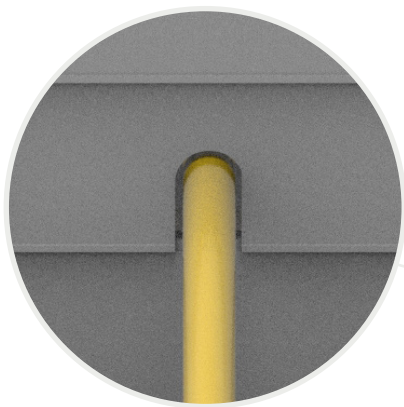

Cut Duct Entry

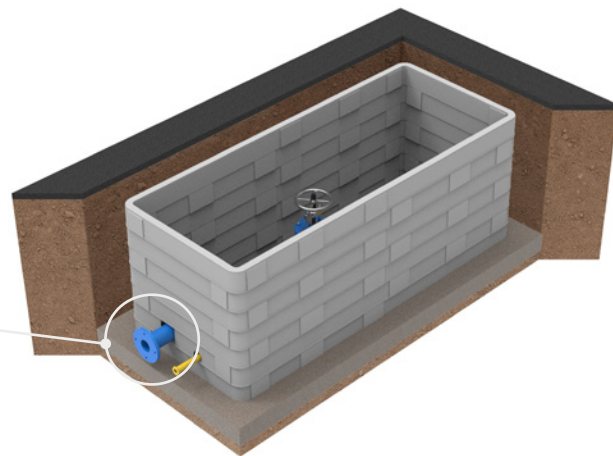
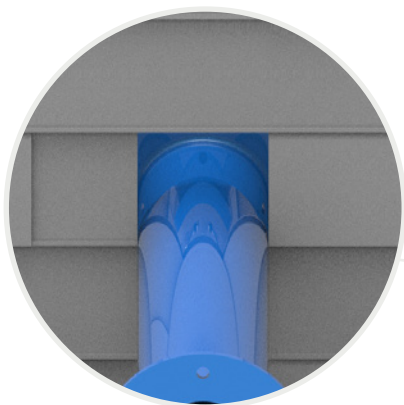

13. Wall Accessories & Cable Management

13.1. Install accessories if required.

a. Wall accessories and cable management can be preinstalled in an Oldcastle Infrastructure factory or installed on site. Wall accessories should be installed before backfill when installing on site.

1. Position as per the client's specifications and fix to the chamber. Standard hardware sizes may be used.

a. Consider the final position of the frame (especially cross beams and cross pieces) when installing accessories to avoid clashes.

Cable Bracket



Wall Bearer



Steps

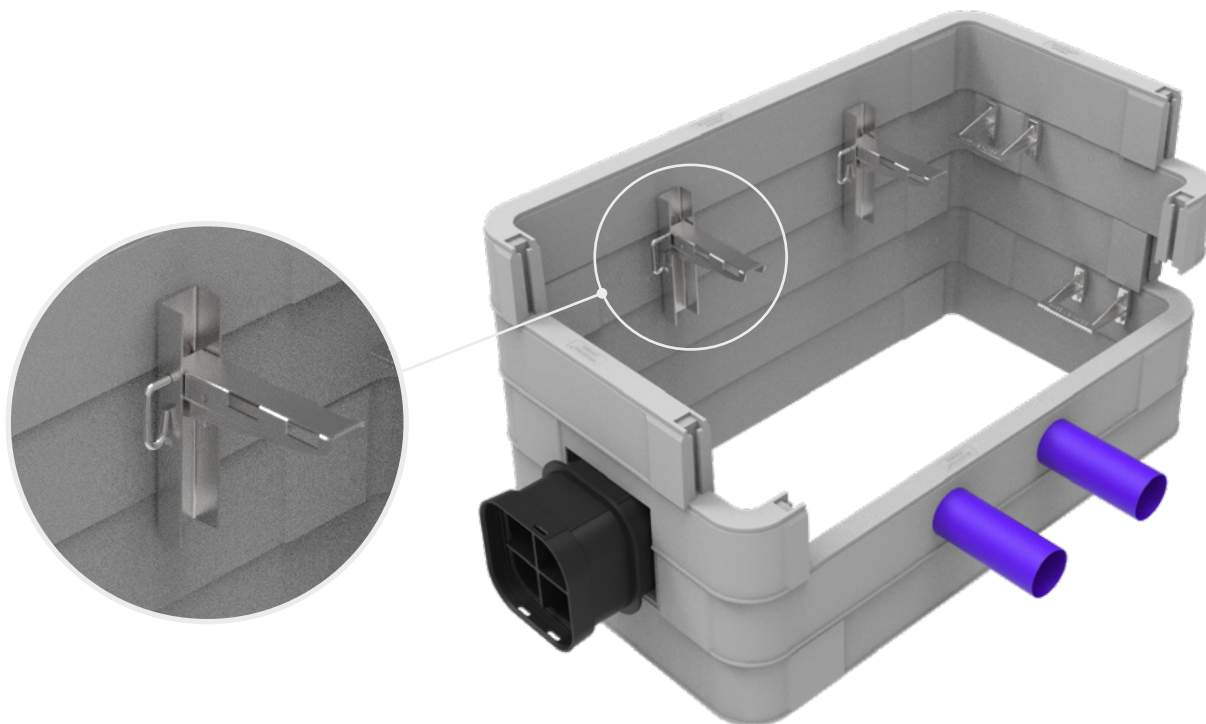
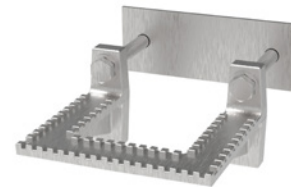

14. Backfill Bracing

14.1. Install temporary bracing if required.

- a. Use timber/wood as shown in image below to spread load along chamber depth.
 1. Chamber sidewall > 39 inches but ≤ 78 inches requires single central bracing
 2. Chamber sidewall > 78 inches requires bracing for every 39 inches interval as a minimum
 3. Cross bracing should be the full depth of the chamber
- b. Make sure internal chamber dimensions are correct once braced. Take care to avoid under or over bracing.

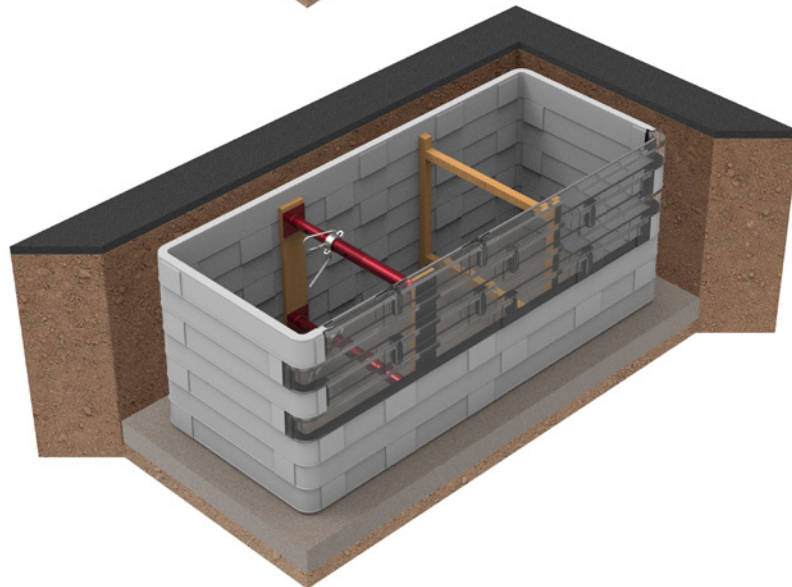
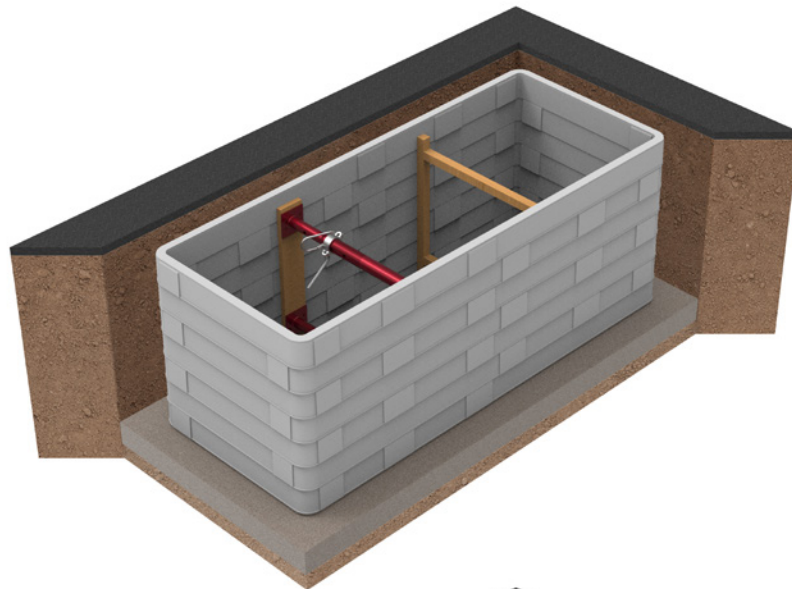

15. Chamber Backfill

15.1. Complete the backfill to the top of the chamber or base of the pavement construction.

- a. Granular backfill must be built in well compacted layers^[1].
- b. Concrete backfill must be appropriately compacted.

15.2. Leave bracing in place until the backfill is complete.

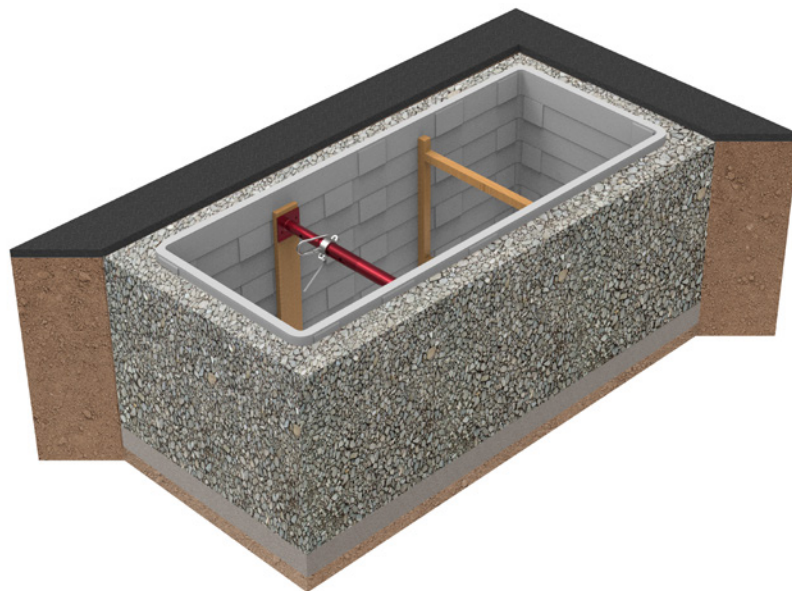
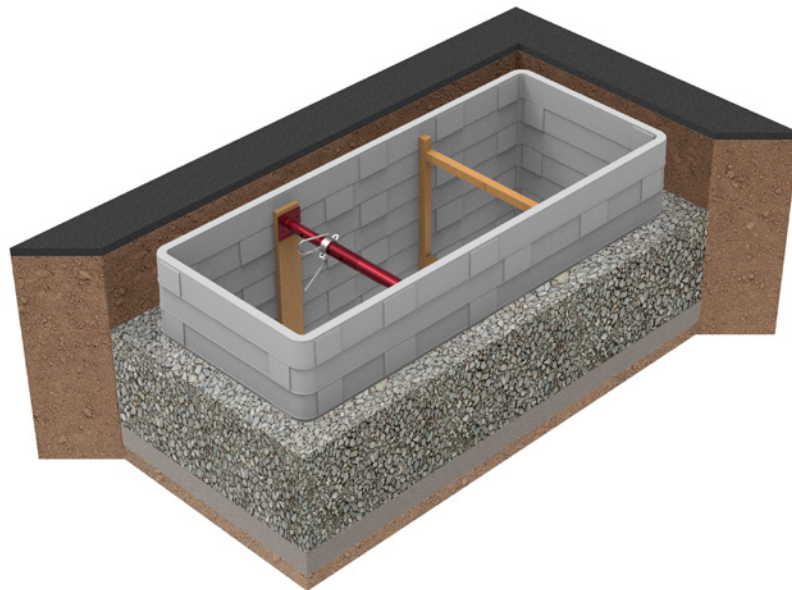

16. Depth Adjustment

16.1. If the chamber depth has been miscalculated and cannot be corrected by packing under the frame it is possible to cut the top ring section down to the correct level.

16.2. Fill the voids of the top ring section to provide a solid base for the frame to be bedded onto.

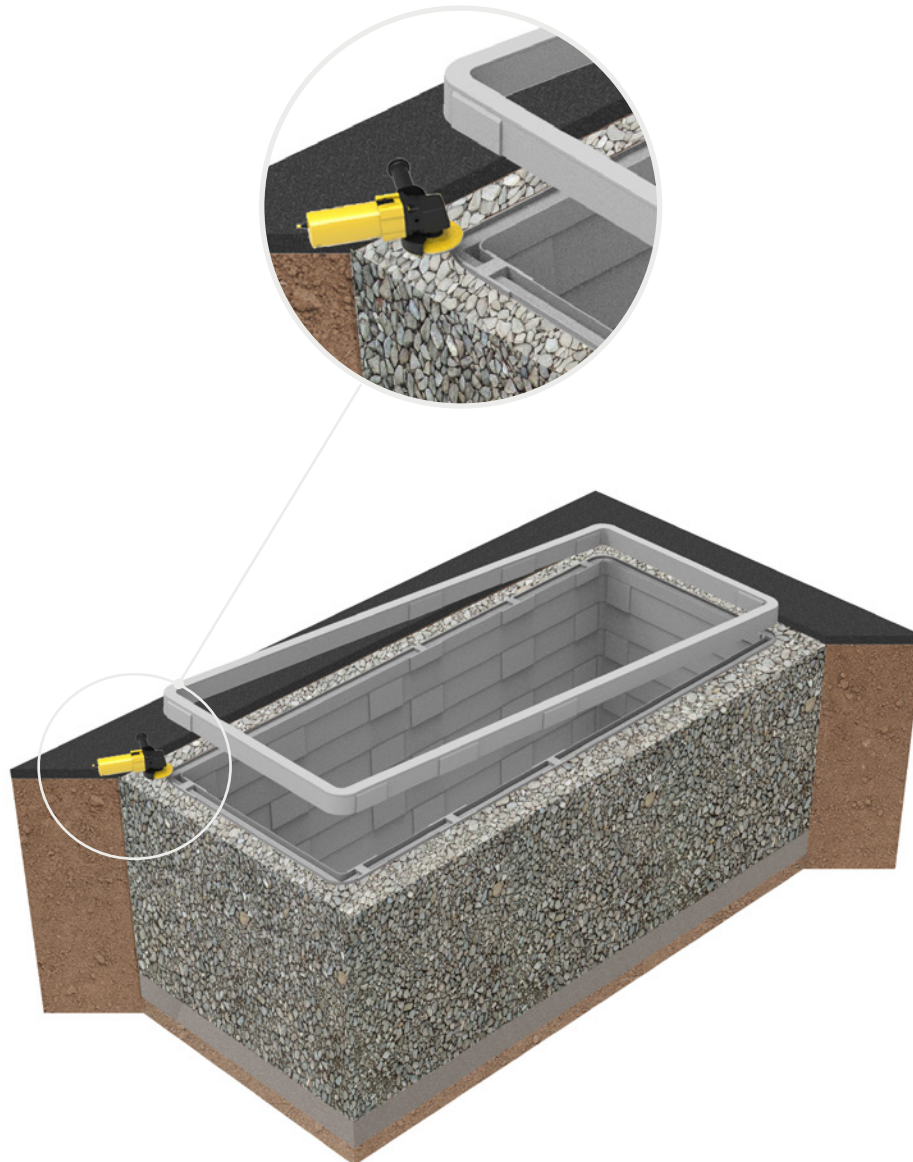

17. Frame and Cover Installation

17.1. Check the required mortar bed depth. Dependant on local regulations, butyl may be used in place of mortar.

17.2. Apply the mortar bed.

- a. Loading environments of H20 roadway applications require a appropriate mortar with a minimum tensile strength of 5N/mm²^[1].
- b. The bed should be 0.5 inches higher than required and 1 inch wider than the spread of the underside of the frame.

17.3. Place the frame on the mortar bed.

- a. Ensure it is aligned with the chamber.

17.4. Tap the frame so that it beds into the mortar bed.

- a. Ensure it is aligned with the finished ground level.

17.5. Apply mortar over the exterior flanges of the frame. See mortar detail below.

17.6. Remove excess mortar.

17.7. Gently place the beams and covers into the frame while the mortar bed cures.

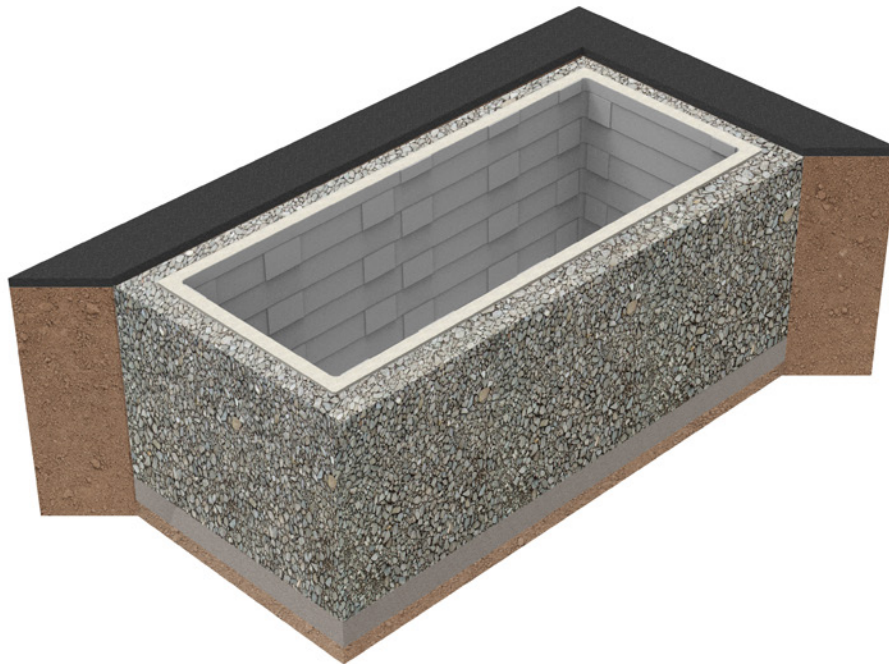

Mortar Detail

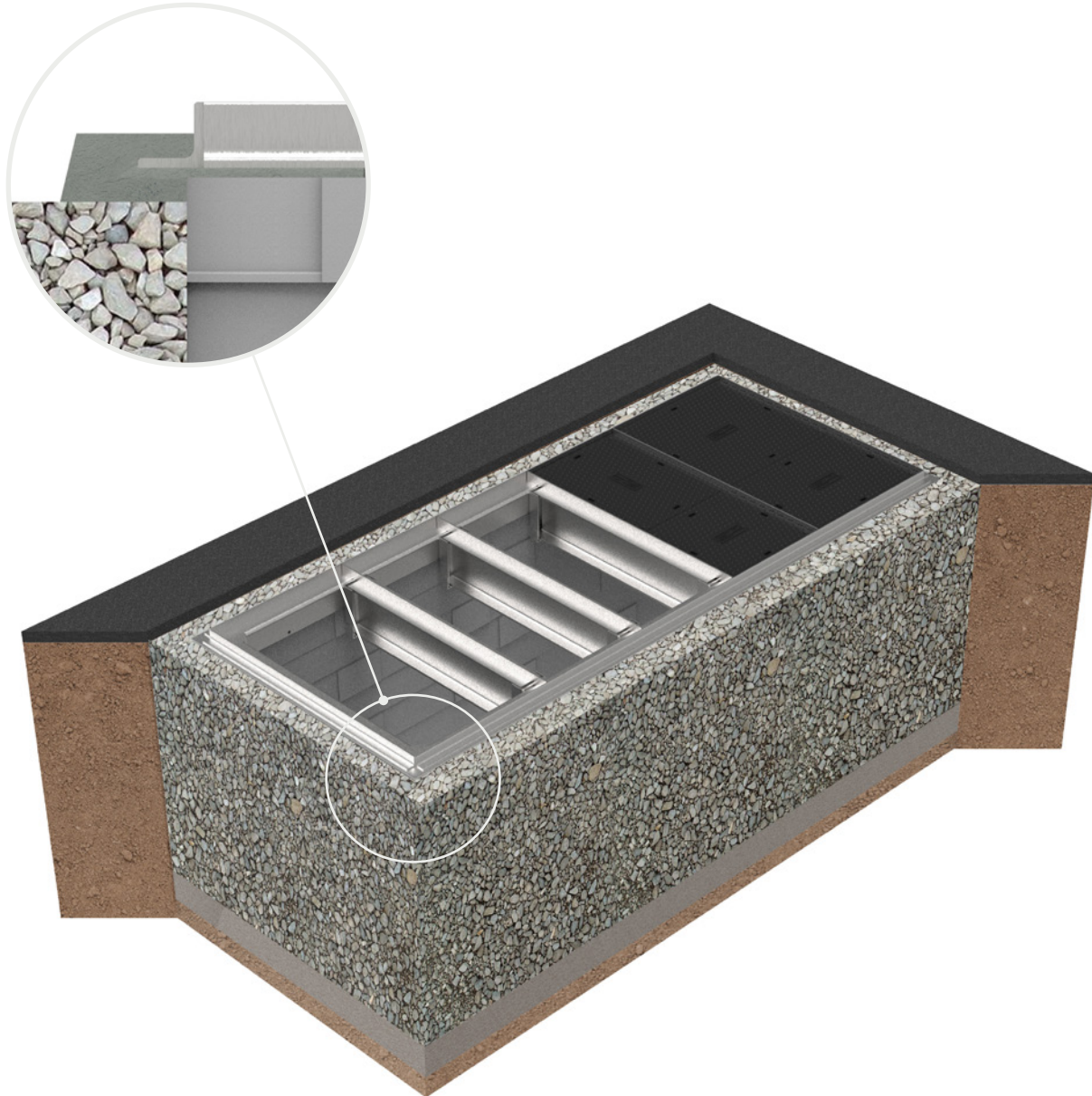

18. Slab Installation

18.1. Excavate at a minimum to the extents shown in the drawing below: length of slab, width of slab and depth of chamber +6 inches.

18.2. Assemble chamber per instructions and install conduit, if applicable.

18.3. Backfill as shown with crushed stone, graded aggregate base, or similar granular, compactible material and compact per project specifications and/or guidelines per jurisdiction, whichever is more conservative. Dimensions shown are minimum criteria for backfill and shall, at a minimum, preclude environmental hazards such as frost heave, thaw weakening, high water table and similar. Consult with geotechnical engineer as needed.

NOTE: Backfill should be brought up to just above top level of chamber, as settling will occur.

18.4. Set slab in place on chamber using embedded lifters, ensuring that center of chamber is aligned with center of socket and ensuring a level bearing surface for the slab.

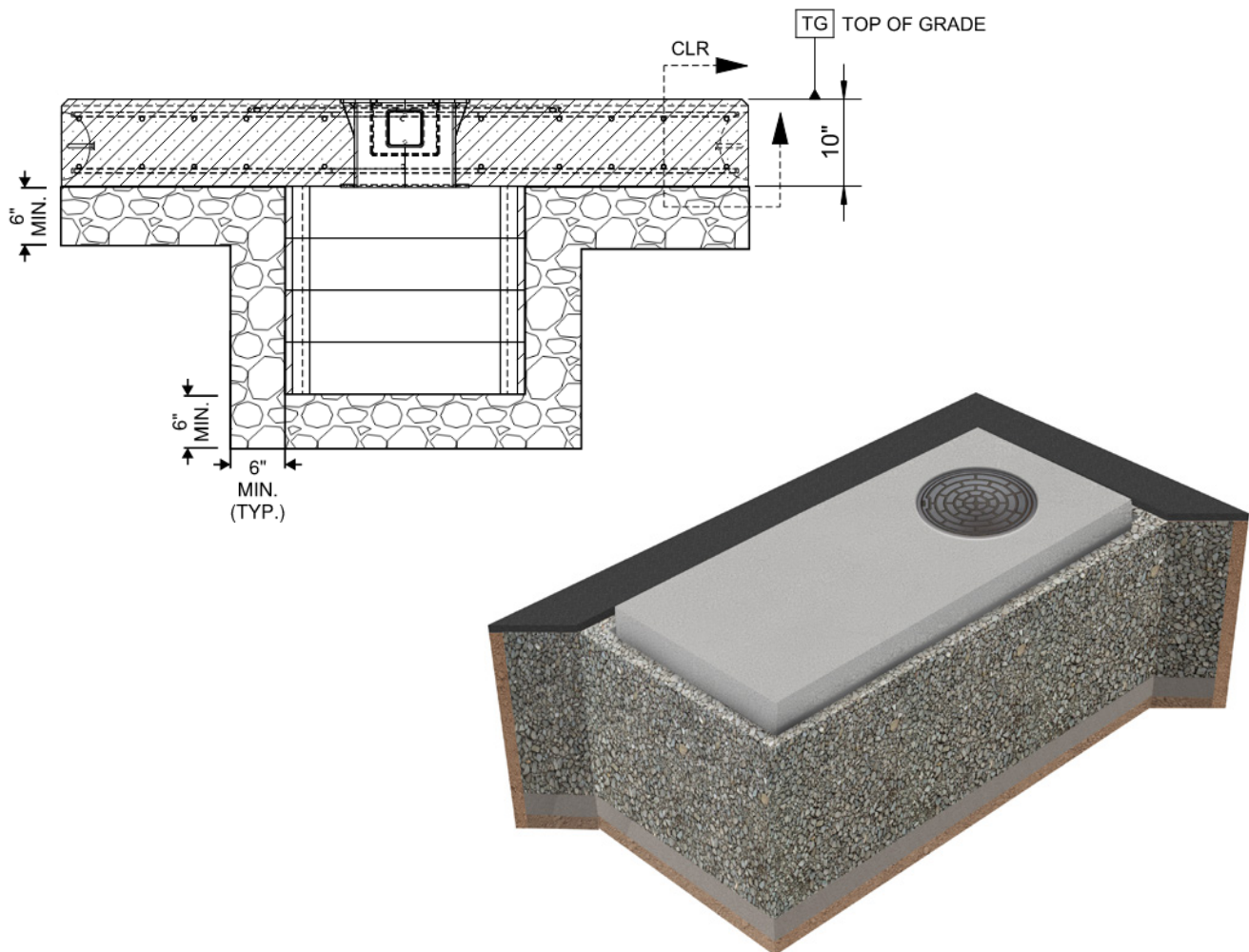

19. Ground Level Reinstatement

19.1. Complete the ground construction to the finished surface level as per the client's specifications^[1].

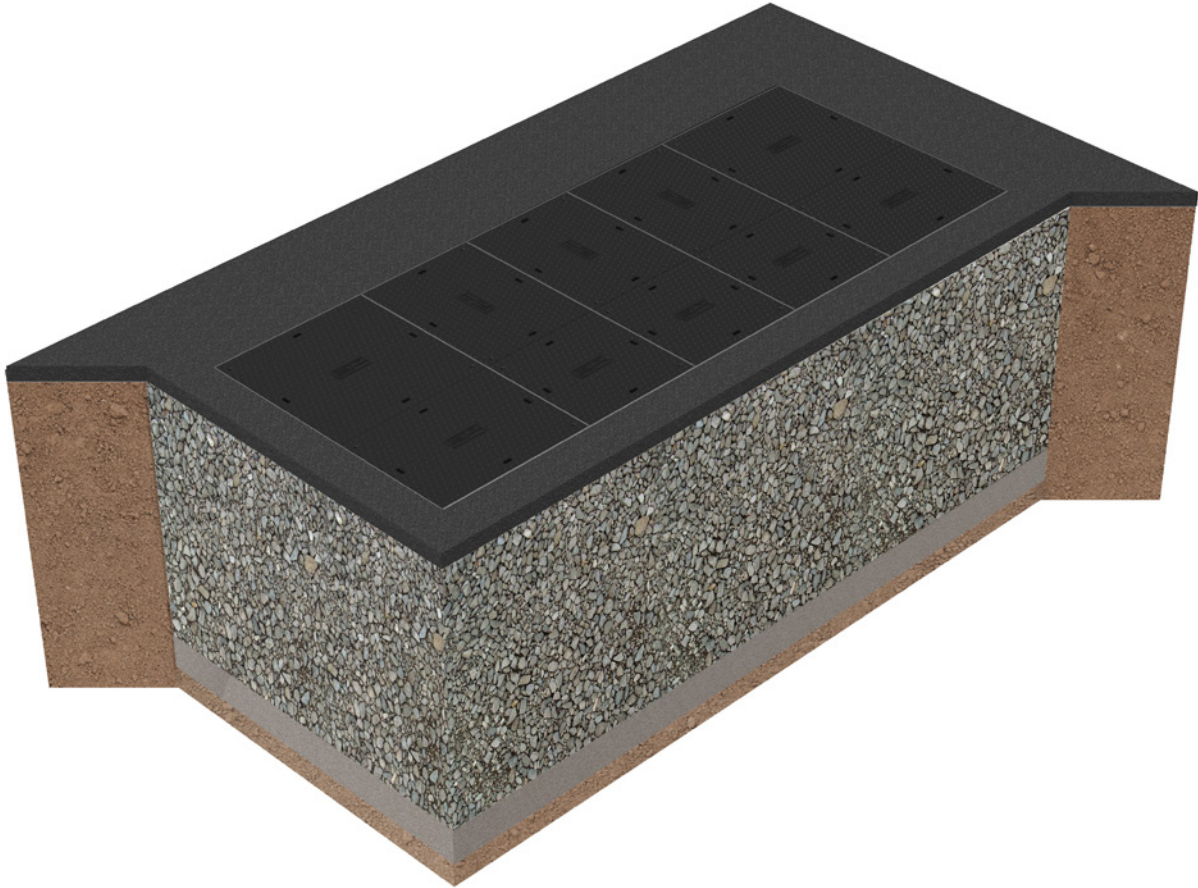

Notes

- [1] As per the requirements of “Specification for the Reinstatement of Openings in Highways - Appendix A8” or equivalent local/national standard in the USA, if it exists.
- [2] Preferably diamond tipped.
- [3] As per the STAKKAbox ULTIMA Connect Assembly Guide.

For advice and guidance beyond the specifications of this Installation Guide please contact an Oldcastle Infrastructure representative.

Oldcastle Infrastructure makes no express or implied warranty or guarantee of the techniques, construction methods or materials identified herein.

The customer shall comply with all laws, regulations, codes and orders of any authority having jurisdiction over the customer and which relate to the customer’s installation, maintenance and use of Oldcastle Infrastructure products. If the customer’s installation or use of any products contravenes any such laws, regulations, codes or orders of such authorities, the customer shall be responsible for the violations thereof and shall bear the costs, expense and damages attributable to its failure to comply with the provisions of such laws, ordinances, rules, regulations, codes or orders.

Reproduction of the material herein is not permitted without the written consent of Oldcastle Infrastructure.





www.oldcastleinfrastructure.com | (888) 965-3227

Trusted partnerships.
Full scale solutions.